

# Residential

## **L** LEW ELECTRIC FITTINGS COMPANY

SERVING THE ELECTRICAL INDUSTRY SINCE 1901

Log on  
for complete  
[www.lewelectric.com](http://www.lewelectric.com)  
line catalog and  
specifications

**NEW**  
see page 9

**NEW**  
see page 11



<b>812Series</b>	<b>612Series</b>
<b>RRPSeries</b>	<b>1101-SPSeries</b>
<b>SWBSeries</b>	<b>LOW VOLT</b>
<b>RCFBSeries</b>	<b>Connectivity</b>

Catalog #106R  
[www.lewelectric.com](http://www.lewelectric.com)



2

<b>812Series</b>	<b>612Series</b>
<b>RRPSeries</b>	<b>1101-SPSeries</b>
<b>SWBSeries</b>	<b>LOW VOLT</b>
<b>RCFBSeries</b>	Connectivity



« 812-DFB; page 4

SWB-4-PQ; page 9 »



« TCP-2-LR-A; page 5



RCFB-1; page 11 »



« SWB-2-NS; page 9



« 612-RSS-2; page 13



## WHAT WE DO

We make electrical floor boxes safer to use residentially and commercially—*worldwide*.

We are the market leading provider of residential floor boxes as well as manufacturers of floor boxes for homes, churches, airports, sports stadiums, highways—any type of facility that needs electrical boxes where wall boxes are insufficient.

## HISTORY

Lew Electric Fittings Company is a family owned and operated company founded in 1901. Our founder, Jake Lewin, started with only one floor box. "Lew" used incomparable quality in materials and craftsmanship, and insisted on providing personal customer service, turning that one floor box into the largest variety of boxes in the industry today.

## TABLE OF CONTENTS

<b>812 Series</b> . . . . .	<b>3</b>
<b>RRP Series</b> . . . . .	<b>8</b>
<b>SWB Series</b> . . . . .	<b>9</b>
<b>RCFB Series</b> . . . . .	<b>11</b>
<b>612 Series</b> . . . . .	<b>13</b>
<b>1101-SP Series</b> . . . . .	<b>14</b>
<b>LOW VOLTAGE CONNECTIVITY Series</b> . .	<b>15</b>
<b>Crossovers</b> . . . . .	<b>16</b>

•812Series	612Series
RRP Series	1101-SP Series
SWB Series	LOW VOLT
RCFB Series	Connectivity

# 812 Boxes *(pages 3 & 4)*

CATALOG #	DESCRIPTION	DIMENSIONS		CONDUIT OPENINGS	INTERIOR CAPACITY
		A	B		
812	CAST IRON ROUND FLOOR BOX WITH RECEPTACLE. DOES NOT INCLUDE COVER	4"	3 1/8"	SIDES (2)-3/4" & (2)-1/2" BOTTOM (2)-1/2"	14.5 CI
812-DFB-LR	FLOOR BOX FURNISHED WITH DFB-LR BRASS COVER & 15 AMP RECEPTACLE	4"	3 3/8"	SIDES (2)-3/4" & (2)-1/2" BOTTOM (2)-1/2"	14.5 CI
812-DFB-LR-A	FLOOR BOX FURNISHED WITH DFB-LR-A (ALUMINUM) COVER & 15 AMP RECEPTACLE	4"	3 3/8"	SIDES (2)-3/4" & (2)-1/2" BOTTOM (2)-1/2"	14.5 CI
812-DFB W/DFB-1	FLOOR BOX FURNISHED WITH DFB-1 BRASS COVER & 15 AMP RECEPTACLE	4"	3 3/8"	SIDES (2)-3/4" & (2)-1/2" BOTTOM (2)-1/2"	14.5 CI
812-DFB W/DFB-1-A	FLOOR BOX FURNISHED WITH DFB-1-A (ALUMINUM) COVER & 15 AMP RECEPTACLE	4"	3 3/8"	SIDES (2)-3/4" & (2)-1/2" BOTTOM (2)-1/2"	14.5 CI

□ 812 SERIES UL. LISTED FOR USE IN WOOD OR CONCRETE

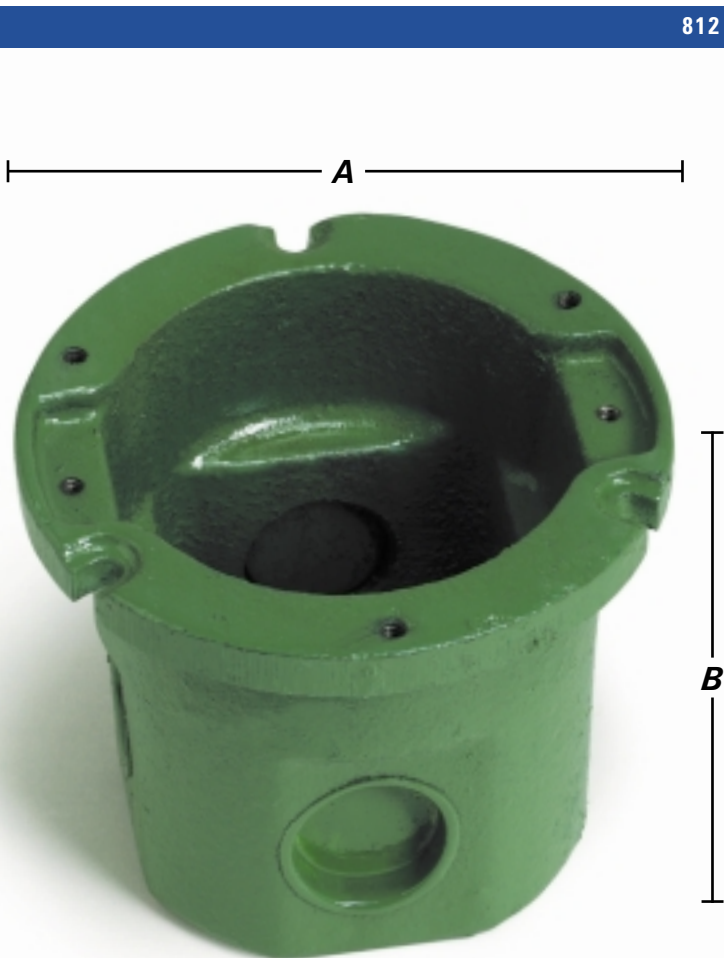

**ADDITIONAL 812 SERIES BOXES ON PAGE 4**



4

• <b>812Series</b>	<b>612Series</b>
<b>RRPSeries</b>	<b>1101-SPSeries</b>
<b>SWBSeries</b>	<b>LOW VOLT</b>
<b>RCFBSeries</b>	Connectivity

(pages 3 & 4) **Boxes 812**

CATALOG #	DESCRIPTION	DIMENSIONS		CONDUIT OPENINGS	INTERIOR CAPACITY
		A	B		
<b>812-DFB</b>	FLOOR BOX FURNISHED WITH 523-DP BRASS COVER & 15 AMP RECEPTACLE	4"	3 1/8"	SIDES (2)-3/4" & (2)-1/2" BOTTOM (2)-1/2"	14.5 CI
<b>812-DFB-A</b>	FLOOR BOX FURNISHED WITH 523-DP-A (ALUMINUM) COVER & 15 AMP RECEPTACLE	4"	3 1/8"	SIDES (2)-3/4" & (2)-1/2" BOTTOM (2)-1/2"	14.5 CI
<b>812-DFB-NS</b>	FLOOR BOX FURNISHED WITH 523-DP-NS (NICKEL SILVER) COVER & 15 AMP RECEPTACLE	4"	3 1/8"	SIDES (2)-3/4" & (2)-1/2" BOTTOM (2)-1/2"	14.5 CI
<b>812-DFB-W/524</b>	FLOOR BOX FURNISHED WITH 524 BRASS COVER AND TEL. JACK	4"	3 1/8"	SIDES (2)-3/4" & (2)-1/2" BOTTOM (2)-1/2"	14.5 CI
<b>812-DFB-W/524-NS</b>	FLOOR BOX FURNISHED WITH 524-NS (NICKEL SILVER) COVER AND TEL. JACK	4"	3 1/8"	SIDES (2)-3/4" & (2)-1/2" BOTTOM (2)-1/2"	14.5 CI

NEW

812 SERIES UL LISTED FOR USE IN WOOD OR CONCRETE

812-DFB



812-DFB-A



812-DFB-NS



812-DFB W/524



812-DFB W/524-NS



**ADDITIONAL 812 SERIES BOXES ON PAGE 3**

•812Series	612Series
RRP Series	1101-SP Series
SWB Series	LOW VOLT
RCFB Series	Connectivity

## 812 Covers

CATALOG #	DESCRIPTION
DFB-LR	BRASS, DUAL HINGED COVER (1/4" THICK) FOR DUPLEX
DFB-LR-A	ALUMINUM, DUAL HINGED COVER (1/4" THICK) FOR DUPLEX
DFB-1	BRASS, HINGED COVER (1/4" THICK) FOR DUPLEX
DFB-1-A	ALUMINUM, HINGED COVER (1/4" THICK) FOR DUPLEX
TCP-2*	5 3/4" BRASS FLANGED COVER, W/ (2) 1 1/2", SCREW PLUGS FOR DUPLEX POWER OR COMM./DATA
TCP-2-A* (NEW)	5 3/4" ALUMINUM FLANGED COVER, W/ (2) 1 1/2", SCREW PLUGS FOR DUPLEX POWER OR COMM./DATA
TCP-2-LR*	5 3/4" SEAMLESS BRASS FLANGED COVER, W/ DUAL FLIP LID AND DUPLEX MOUNT. PLT.
TCP-2-LR-A*	5 3/4" SEAMLESS ALUMINUM FLANGED COVER, W/ DUAL FLIP LID AND DUPLEX MOUNT. PLT.
523-DP	BRASS, COVER (1/8" THICK) WITH (2) 1-1/2" SCREW PLUGS FOR DUPLEX
523-DP-A (NEW)	ALUMINUM, COVER (1/8" THICK) WITH (2) 1-1/2" SCREW PLUGS FOR DUPLEX
523-DP-NS	NICKEL SILVER, COVER (1/8" THICK) WITH (2) 1-1/2" SCREW PLUGS FOR DUPLEX
524	BRASS, COVER (1/8" THICK) WITH 2" - 1/2" COMBO PLUG FOR COMM./DATA
524-NS	NICKEL SILVER, COVER (1/8" THICK) WITH 2" - 1/2" COMBO PLUG FOR COMM./DATA

□ ALL COVERS 4" UNLESS INDICATED BY \*



• 812Series	612Series
RRP Series	1101-SP Series
SWB Series	LOW VOLT
RCFB Series	Connectivity

## Flanges and Accessories 812

CATALOG#	DESCRIPTION
SCF-1	BRASS, FLANGE 5 1/4" DIAMETER
SCF-1-CP	CLEAR PLASTIC, FLANGE 5 3/4" DIAMETER
SCF-1A	ALUMINUM, FLANGE 5 1/4" DIAMETER
225-R	1/2" SHORT RADIUS BENDER
812-MKM	DOUBLE CUT HOLE SAW 3 1/2" / 4"



CATALOG #	DESCRIPTION	DIMENSIONS		CONDUIT OPENINGS	INTERIOR CAPACITY
		A	B		
512-U	FLOOR BOX FURNISHED WITH 504 BRASS COVER, 15 AMP RECEPTACLE	3 1/2"	3 1/8"	SIDES (2)-3/4" & (2)-1/2" BOTTOM (2)-1/2"	10 CI
515	FLOOR BOX WITH 503 BRASS COVER FOR COMM./DATA	3 1/2"	3 1/8"	SIDES (2)-3/4" & (2)-1/2" BOTTOM (2)-1/2"	10 CI
CATALOG #	DESCRIPTION				
503	BRASS 3 1/2" COVER WITH 2" - 1/2" COMBO PLUG				
504	BRASS 3 1/2" COVER WITH 2" CLOSE UP PLUG				

□ 512 SERIES UL. LISTED FOR USE IN WOOD OR CONCRETE



812Series	612Series
•RRP Series	1101-SP Series
•SWB Series	LOW VOLT
RCFB Series	Connectivity

# RRP & SWB *Features and Benefits*

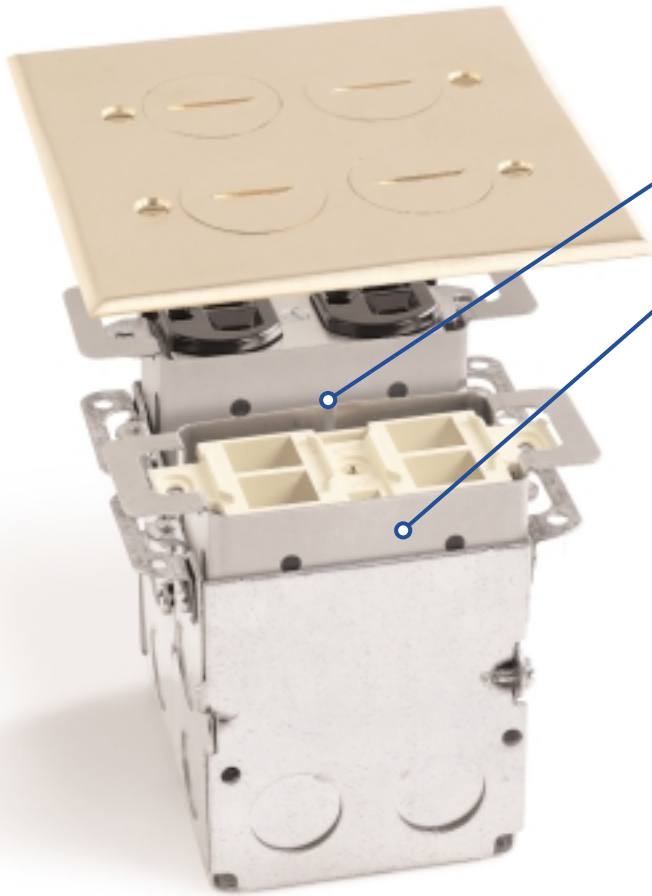

- 1 *Divider included* for power and Comm./Data in the same box
- 2 *3/4 inch adjustable sleeve* accommodates any finished floor

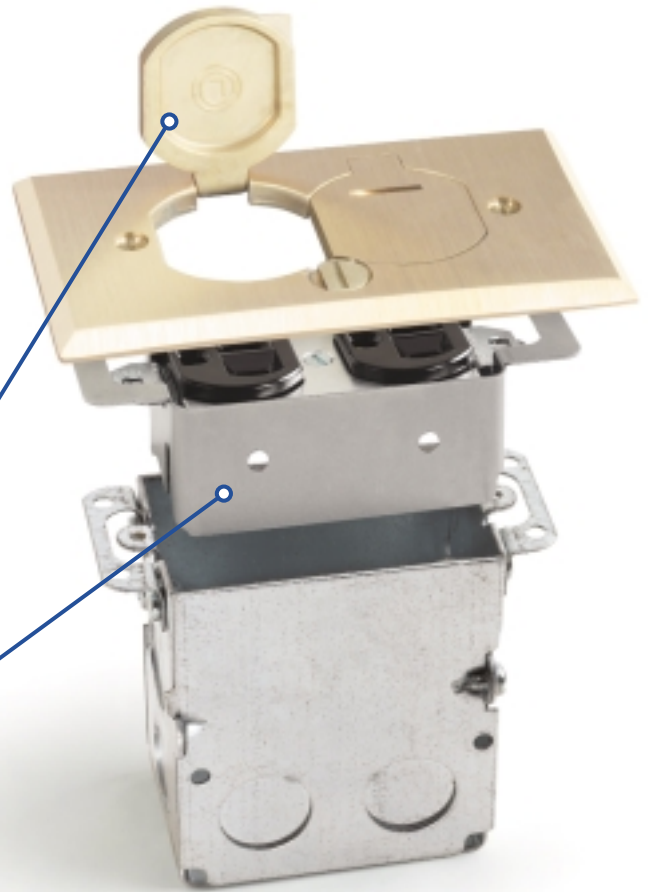

- 1 *Flip lid or screw plug* option
- 2 *3/4 inch adjustable sleeve* accommodates any finished floor



- Available in a variety of finishes: brass, nickel silver, or brushed aluminum
- Install in a new floor or an existing floor

812Series	612Series
• RRP Series	1101-SP Series
SWB Series	LOW VOLT
RCFB Series	Connectivity

## Boxes and Covers **RRP**

CATALOG#	DESCRIPTION
RRP-1	RECESSED FLOOR PLATE ASSEMBLY (SINGLE RECEPTACLE)
RRP-1-T	RECESSED FLOOR PLATE ASSEMBLY (COMM./DATA)
RRP-2	RECESSED FLOOR PLATE ASSEMBLY (DUPLEX RECEPTACLE)
RRP-2-A	ALUMINUM RECESSED FLOOR PLATE ASSEMBLY (DUPLEX RECEPTACLE)
RRP-2-A-T	ALUMINUM RECESSED FLOOR PLATE ASSEMBLY (DUPLEX COMM./DATA)
RRP-2-LR	AVAILABLE MARCH 2006 RECESSED FLOOR PLATE FLIP LID ASSEMBLY (DUPLEX RECEPTACLE)
RRP-2-LR-T	AVAILABLE MARCH 2006 RECESSED FLOOR PLATE FLIP LID ASSEMBLY (DUPLEX COMM./DATA)
RRP-2-LR-A	AVAILABLE MARCH 2006 ALUMINUM RECESSED FLOOR PLATE FLIP LID ASSEMBLY (DUPLEX RECEPTACLE)
RRP-2-LR-A-T	AVAILABLE MARCH 2006 ALUMINUM RECESSED FLOOR PLATE FLIP LID ASSEMBLY (DUPLEX COMM./DATA)
RRP-2-NS	NICKEL-SILVER RECESSED FLOOR PLATE ASSEMBLY (DUPLEX RECEPTACLE)
RRP-2-NS-T	NICKEL-SILVER RECESSED FLOOR PLATE ASSEMBLY (DUPLEX COMM./DATA)
RRP-2-T	RECESSED FLOOR PLATE ASSEMBLY (DUPLEX COMM./DATA)

RRP-1

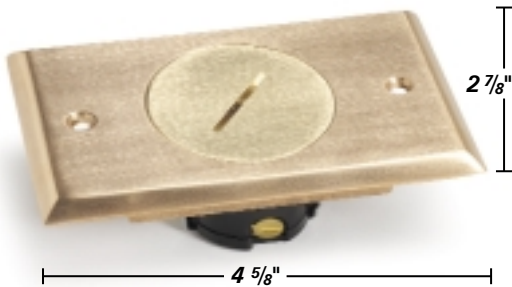

RRP-2

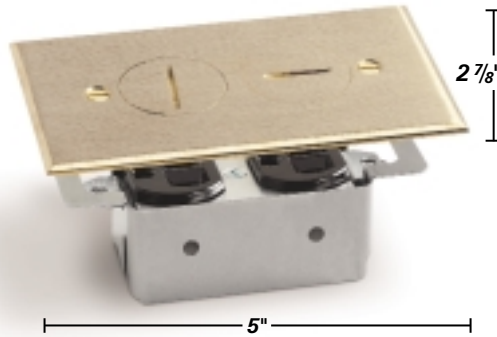

RRP-2-A



RRP-2-LR

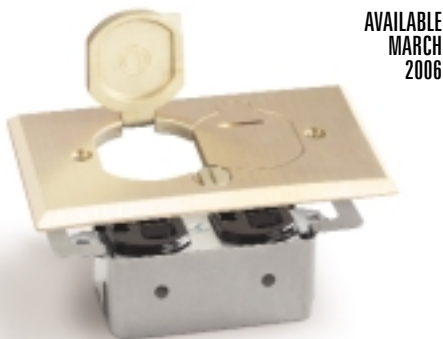

RRP-2-LR-A

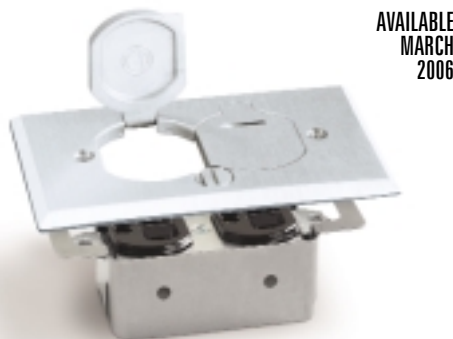

RRP-2-NS



### UL & NEMA RECOGNITION

- WATER TIGHT CLOSE UP PLUG UL LISTING # 489H
- BOX UL #729A (FILE # 10866)
- RECEPTACLE UL LISTING # 947B
- MEETS NEMA WD1-1983 HEAVY DUTY REQUIREMENT FOR DISPLAY RECEPTACLE









### FEATURES AND BENEFITS

- VERSATILE POWER OR COMMUNICATIONS APPLICATIONS
- RECEPTACLE WITH NEOPRENE GASKET INCLUDED
- WATER TIGHT ASSEMBLY

812Series	612Series
RRP Series	1101-SP Series
• SWB Series	LOW VOLT
RCFB Series	Connectivity

## SWB Boxes and Covers

CATALOG#	DESCRIPTION
SWB-1	RECESSED FLOOR PLATE ASSEMBLY (SINGLE RECEPTACLE WITH BOX)
SWB-1-T	RECESSED FLOOR PLATE ASSEMBLY (COMM./DATA WITH BOX)
SWB-2	RECESSED FLOOR PLATE ASSEMBLY (DUPLEX RECEPTACLE WITH BOX)
SWB-2-A	ALUMINUM RECESSED FLOOR PLATE ASSEMBLY (DUPLEX RECEPTACLE WITH BOX)
SWB-2-A-T	ALUMINUM RECESSED FLOOR PLATE ASSEMBLY (COMM./DATA WITH BOX)
SWB-2-LR	AVAILABLE MARCH 2006 RECESSED FLOOR PLATE FLIP LID ASSEMBLY (DUPLEX RECEPTACLE WITH BOX)
SWB-2-LR-T	AVAILABLE MARCH 2006 RECESSED FLOOR PLATE FLIP LID ASSEMBLY (COMM./DATA WITH BOX)
SWB-2-LR-A	AVAILABLE MARCH 2006 ALUMINUM RECESSED FLOOR PLATE FLIP LID ASSEMBLY (DUPLEX RECEPTACLE WITH BOX)
SWB-2-LR-A-T	AVAILABLE MARCH 2006 ALUMINUM RECESSED FLOOR PLATE FLIP LID ASSEMBLY (COMM./DATA WITH BOX)
SWB-2-NS	NICKEL-SILVER RECESSED FLOOR PLATE ASSEMBLY (DUPLEX RECEPTACLE WITH BOX)
SWB-2-NS-T	NICKEL-SILVER RECESSED FLOOR PLATE ASSEMBLY (DUPLEX COMM./DATA WITH BOX)
SWB-2-T	RECESSED FLOOR PLATE ASSEMBLY (DUPLEX COMM./DATA WITH BOX)
SWB-4-PQ	TWO GANG, DIVIDED, RECESSED, FLOOR PLATE ASSEMBLY: ONE POWER & ONE QUAD PORT
SWB-4-2P	TWO GANG, DIVIDED, RECESSED, FLOOR PLATE ASSEMBLY: TWO POWER
SWB-4-2Q	TWO GANG, DIVIDED, RECESSED, FLOOR PLATE ASSEMBLY: TWO QUAD PORTS

SWB-1	SWB-2	SWB-2-A	SWB-2-LR
 <p>□ 2 7/8" W x 4 5/8" L x 4" H □ 18 cu in.</p>	 <p>□ 2 7/8" W x 5" L x 4" H □ 18 cu in.</p>		<p>AVAILABLE MARCH 2006</p> 
SWB-2-LR-A	SWB-2-NS	SWB-4-PQ	
<p>AVAILABLE MARCH 2006</p> 		 <p>□ 5" W x 5" L x 4" H □ 36 cu in.</p>	 <p>□ 2 7/8" W x 5" L x 4" H □ 18 cu in.</p>
<b>UL &amp; NEMA RECOGNITION</b>		<b>FEATURES AND BENEFITS</b>	

- WATER TIGHT CLOSE UP PLUGS UL LISTING # 489H
- BOX UL #729A (FILE #10866)
- RECEPTACLE UL LISTING # 351B
- MEETS NEMA WD1-1983 HEAVY DUTY REQUIREMENT FOR DISPLAY RECEPTACLE

- VERSATILE POWER OR COMMUNICATIONS APPLICATIONS
- WATER TIGHT ASSEMBLY
- 1/2" CONDUIT KNOCKOUTS

10

812Series	612Series
RRPSeries	1101-SPSeries
SWBSeries	LOW VOLT
•RCFBSeries	Connectivity

## Features and Benefits **RCFB**

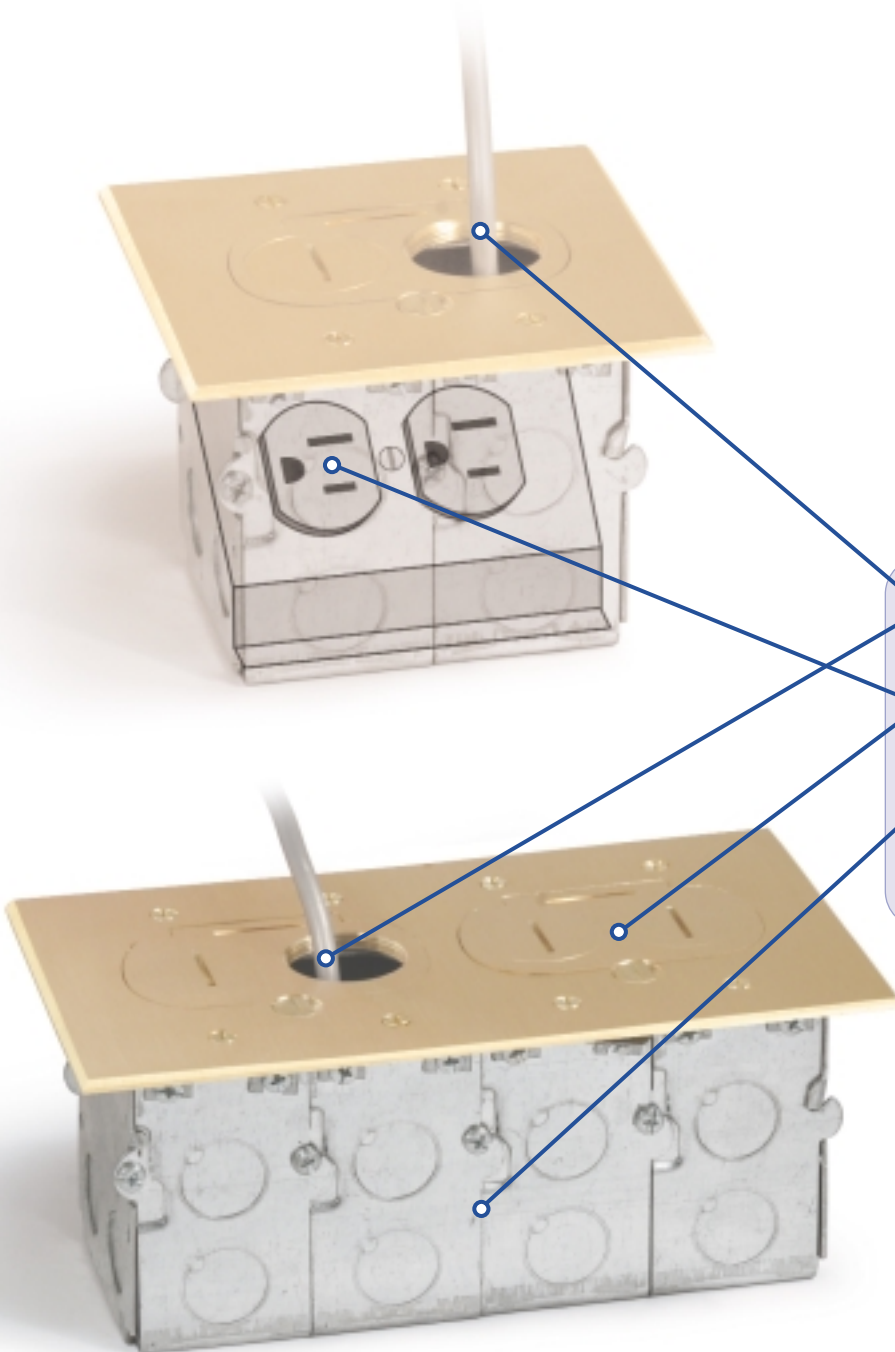

- 1 Plugs or Comm./Data *connections are completely recessed* (RCFB-1)
- 2 *Connections are completely concealed* when the door is closed
- 3 The divider in the RCFB-2 allows you to *combine power and Comm./Data* in the same box

- A true Hybrid Floor box combining the ease of installation of a drop in floor box with the functionality of a concealed service recessed box
- Use Lew's Quad port and any number of our low voltage connector for all of your home theater or Comm./Data needs

812Series  
RRP Series  
SWB Series  
• RCFB Series

612Series  
1101-SP Series  
LOW VOLT  
Connectivity

# RCFB Boxes and Covers

CATALOG#	DESCRIPTION
RCFB-1	AVAILABLE MARCH 2006 RECESSED HYBRID FLOOR BOX
RCFB-2	AVAILABLE MARCH 2006 RECESSED HYBRID TWO-GANG FLOOR BOX

## LEW ELECTRIC NEW HYBRID FLOOR BOX SERIES

Do you want to hide the unsightly plug of your lamp or find a way to manage your home theater connections? Now you can with Lew Electric's new Hybrid floor box series. Our new RCFB Series floor boxes combine the ease of installation of a drop in floor box with the functionality and versatility of a concealed service or recessed floor box. Our huge variety of low voltage connectors which include speaker connectors, RJ45 Cat 5 connectors, and F connectors (RG6), are a snap to put in. Simply use our RRP-2-QP quad communications port and choose up to 4 low voltage communications in conjunction with a duplex receptacle or up to 8 low voltage communications without a duplex receptacle. The possibilities are endless.

RCFB-1

AVAILABLE  
MARCH  
2006



□ 5" W x 5" L x 4" H □ 36 cu in.

RCFB-2

AVAILABLE  
MARCH  
2006

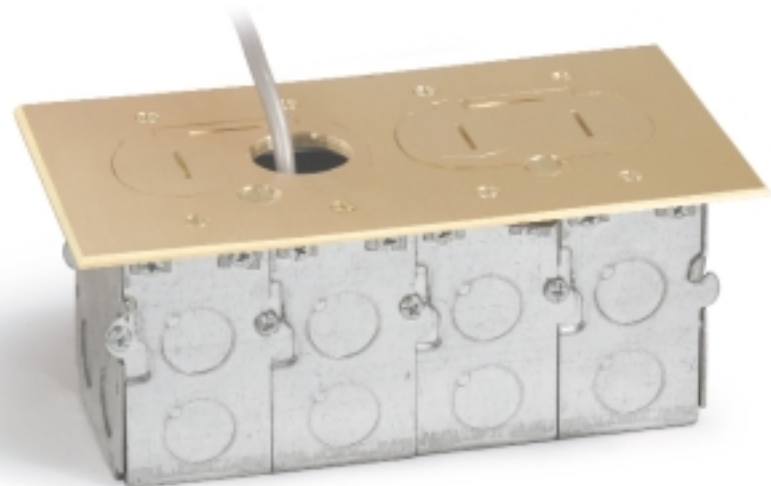

□ 5 1/16" W x 8 5/8" L x 4" H □ 72 cu in.

### UL & NEMA RECOGNITION

- WATER TIGHT CLOSE UP PLUGS UL LISTING # 489H
- BOX UL #729A (FILE #10866)
- RECEPTACLE UL LISTING # 351B

12

812Series	612Series
RRPSeries	1101-SPSeries
SWBSeries	LOW VOLT
RCFBSeries	Connectivity

## Features and Benefits 612

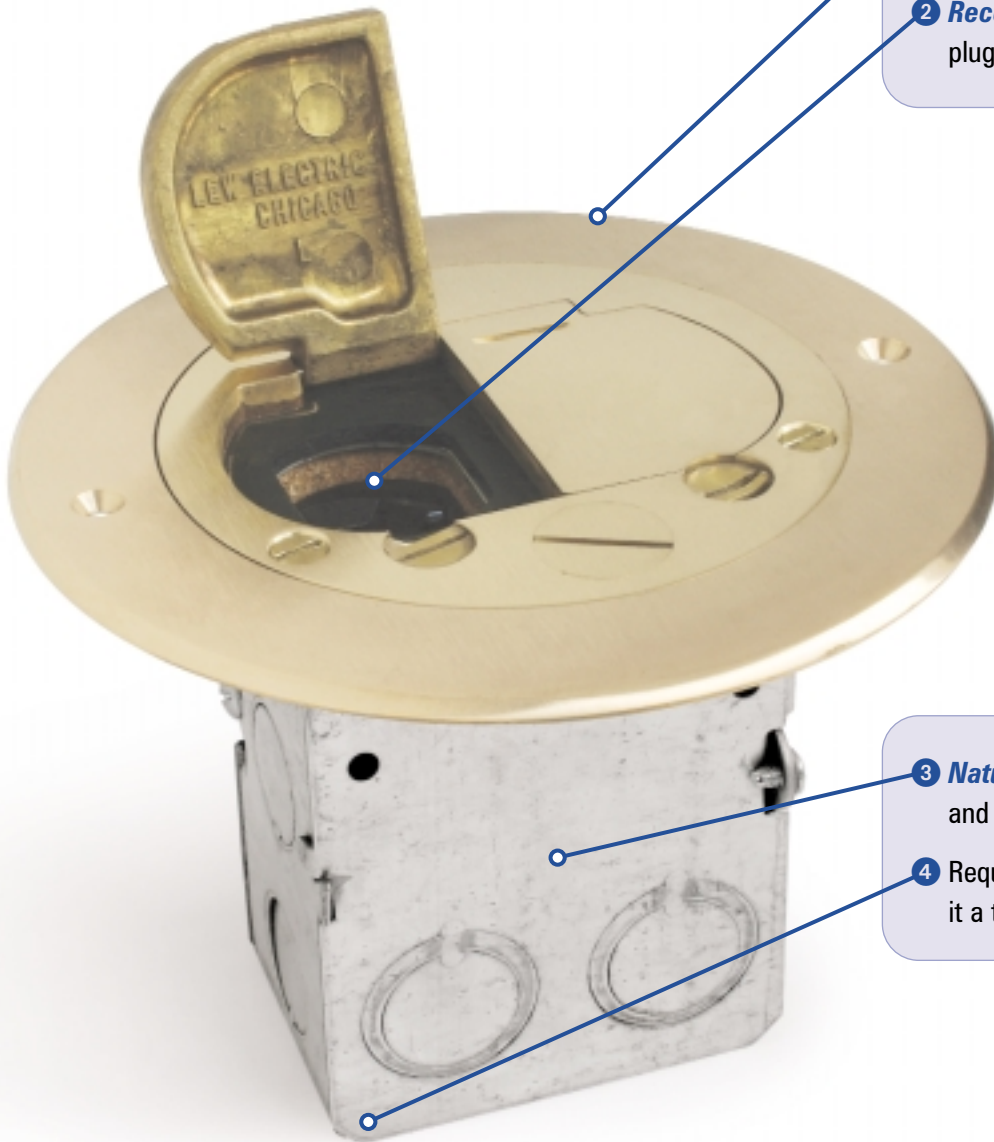

- 1 **Low profile flange** for use on any finished floor
- 2 **Recessed duplex receptacle** protects plugs while in use

- 3 **Natural partition** separates power and Comm./Data in same application
- 4 Requires only a **single hole cut** making it a true drop in style floor box

- Available in brass or brushed aluminum finish
- Available in standard duplex or GFI applications

812Series	•612Series
RRPSeries	1101-SPSeries
SWBSeries	LOW VOLT
RCFBSeries	Connectivity

## 612 Boxes and Covers

CATALOG #	DESCRIPTION	DIMENSIONS		CONDUIT OPENINGS	INTERIOR CAPACITY
		A	B		
612-RSS-1*	RECESSED STAMPED STEEL BOX ASSEMBLY WITH DFB-1-1/2 BRASS COVER AND 15 AMP RECEPTACLE	5 3/4"	4 3/8"	SIDES (8) 1/2" BOTTOM (1) 1/2"	18 CU. IN.
612-RSS-1-GFI*	RECESSED STAMPED STEEL BOX ASSEMBLY WITH DFB-1-1/2 BRASS COVER AND DECORA MOUNTING PLATE	5 3/4"	4 3/8"	SIDES (8) 1/2" BOTTOM (1) 1/2"	18 CU. IN.
612-RSS-1-TEL*	RECESSED STAMPED STEEL BOX ASSEMBLY WITH DFB-1-1/2 COVER AND COMMUNICATION MOUNTING PLATE	5 3/4"	4 3/8"	SIDES (8) 1/2" BOTTOM (1) 1/2"	18 CU. IN.
612-RSS-2*	RECESSED STAMPED STEEL BOX ASSEMBLY WITH DFB-LR-1/2 BRASS COVER AND 15 AMP RECEPTACLE	5 3/4"	4 3/8"	SIDES (8) 1/2" BOTTOM (1) 1/2"	18 CU. IN.

CATALOG#	DESCRIPTION
DFB-1-1/2	BRASS HINGED 4" COVER (1/4" THICK) FOR DUPLEX WITH 1/2" PLUG FOR COMM./DATA
DFB-1-1/2-A	ALUMINUM HINGED 4" COVER (1/4" THICK) FOR DUPLEX WITH 1/2" PLUG FOR COMM./DATA
DFB-LR-1/2	BRASS DUAL HINGED COVER (1/4" THICK) FOR DUPLEX WITH 1/2" PLUG FOR COMM./DATA
DFB-LR-1/2-A	ALUMINUM DUAL HINGED COVER (1/4" THICK) FOR DUPLEX WITH 1/2" PLUG FOR COMM./DATA

\*AVAILABLE IN ALUMINUM FINISH (ADD-A)



14

812Series	612Series
RRPSeries	• 1101-SPSeries
SWBSeries	LOW VOLT
RCFBSeries	Connectivity

## Boxes and Covers 1101-SP

CATALOG #	DESCRIPTION	BOX			W/FLANGE			CONDUIT OPENINGS	INTERIOR CAPACITY
		H	W	L	H	W	L		
1101-SP*	SINGLE GANG CAST BOX WITH BRASS CARPET FLANGE	3 1/2"	3 5/16"	4 3/16"	4"	4 1/2"	5 1/2"	SIDES (4)-3/4" BOTTOM-REQUEST	30.8 CI
6262-SP*	TWO GANG PARTITIONED CAST BOX WITH BRASS CARPET FLANGE	3 3/8"	4 1/4"	6 1/2"	4"	5 3/8"	7 1/4"	SIDES (6)-3/4" BOTTOM-REQUEST	62 CI
6263-SP*	THREE GANG PARTITIONED CAST BOX WITH BRASS CARPET FLANGE	3 3/8"	4 1/4"	9 3/8"	4"	5 3/8"	9 3/8"	SIDES (8)-3/4" BOTTOM-REQUEST	112.5 CI
CATALOG#	DESCRIPTION								
6304-BE	BRASS, HINGED 2 7/8" X 3 7/8" COVER (1/4" THICK) FOR DATA OR TWIST LOCK RECEPT. (UP TO 30 AMP)								
6304-DFB-LR*	BRASS, DUAL HINGED 2 7/8" X 3 7/8" COVER (1/4" THICK) FOR DUPLEX								
6304-DFB-1*	BRASS, HINGED 2 7/8" X 3 7/8" COVER (1/4" THICK) FOR DUPLEX								
6304-DFB-1-TEL*	SAME AS ABOVE BUT FOR COMM./DATA								
6304-DFB-1-GFI*	SAME AS ABOVE BUT FOR DECORA RECEPTACLE								

\*AVAILABLE IN ALUMINUM FINISH (ADD-A)

<p>1101-SP</p> 	<p>6262-SP</p> 	<p>6262-SP-A</p> 	
<p>6263-SP</p> 	<p>6304-DFB-1</p> 	<p>6304-DFB-1-A</p> 	
<p>6304-DFB-LR</p> 	<p>6304-DFB-LR-A</p> 	<p>6304-BE</p> 	<p><b>BOXES &amp; COVERS ARE PACKAGED TOGETHER AS ONE UNIT. (INDIVIDUAL COVERS MAY BE PURCHASED SEPARATELY)</b></p>

812Series	612Series
RRP Series	1101-SP Series
SWB Series	• LOW VOLT
RCFB Series	Connectivity

# LOW VOLT *Connectivity*

CATALOG#	DESCRIPTION
RRP-2-PQ	QUAD PORT
L310-106AL	ALMOND KEYSTONE JACK
L310-110AL	RJ45 ALMOND CAT5E KEYSTONE JACK
L310-130AL	RJ45 ALMOND CAT5E TOOL-LESS JACK
L310-140AL	RJ45 ALMOND CAT6 KEYSTONE JACK
L310-410AL	BNC ALMOND KEYSTONE INSERT
L310-415AL	ALMOND KEYSTONE INSERT
L310-420AL	BLANK ALMOND KEYSTONE COVER
L310-452WH	S-VIDEO JACK-JACK WHITE
L310-461AL	RCA ALMOND RED BAND-GOLD
L310-462AL	RCA ALMOND BLACK BAND-GOLD
L310-463AL	RCA ALMOND WHITE BAND-GOLD
L310-464AL	RCA ALMOND YELLOW BAND-GOLD
L310-470WH	ST-ST FIBER WHITE
L310-471WH	ST-SC FIBER WHITE

RRP-2-PQ



L310-106AL



L310-110AL



L310-130AL



L310-140AL



L310-410AL



L310-462AL

L310-461AL

L310-464AL

L310-463AL

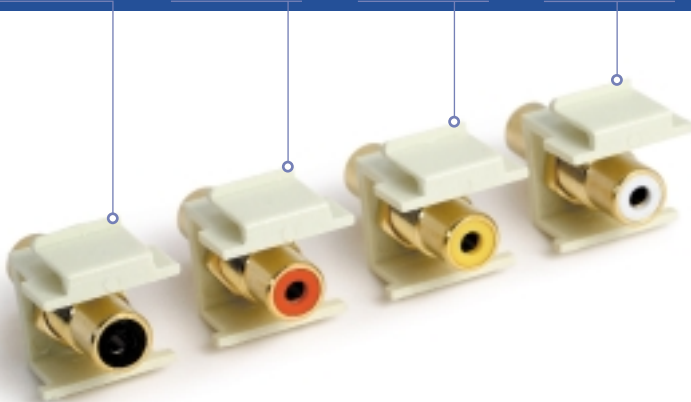

L310-415AL



L310-420AL



L310-452WH



L310-470WH



L310-471WH



16

<b>812Series</b>	<b>612Series</b>
<b>RRPSeries</b>	<b>1101-SPSeries</b>
<b>SWBSeries</b>	<b>LOW VOLT</b>
<b>RCFBSeries</b>	<b>Connectivity</b>

## Crossovers

<i>LEW</i>	<i>STEEL CITY</i>	<i>HUBBELL</i>	<i>WIREMOLD</i>
<b>DFB-1</b>	P60-GFCI	NA	895TGFI
<b>DFB-LR</b>	P60-DS	S3925	895T
<b>SCF-1</b>	P60-CP	S3182	NA
<b>SCF-1-CP</b>	P60-LCP	S3079	NA
<b>SWB-2-LR</b>	71W-DS	NA	NA
<b>SWB-2-LR-A</b>	71W-DS-N	NA	NA
<b>TCP-2-LR</b>	P60CACP	SF3925	895
<b>TCP-2-LR-A</b>	P60CACP-AL	NA	895-P-AL
<b>1101SP</b>	61-W	NA	880W1 +817C
<b>504</b>	P67-2	S2930	NA
<b>512-U</b>	672	B2589 + S2930	859SR
<b>523-DP</b>	P60-DU	S3725	895TSP
<b>523-DP-A</b>	P60-DU-AL	SA3725	NA
<b>524</b>	P60-1/2-2	NA	896-TCK-1/2
<b>524-3/4</b>	P60-3/4-2	S2525	896-TCK-3/4
<b>524-1</b>	NA	S2725	896-TCK-1
<b>6262SP</b>	62-W	NA	880W2 +827C
<b>6263SP</b>	NA	NA	880W3 +837C
<b>6304DP</b>	P64-DU	S3625	828P
<b>6304DFB-1</b>	P64-GFCI	S3826	828GFI
<b>6304DFB-LR</b>	P64-DS	S3825	828R
<b>812DFB</b>	NA	B2588275+S3725	859+895TSP
<b>812DFB-LR</b>	NA	B2588275+S3925	859DR
<b>812DFBw/DFB-1</b>	NA	NA	859+895TGFI
<b>812DFBw/524</b>	NA	NA	859+896-TCK-1/2

## LEW ELECTRIC FITTINGS CO.

1801 W. St. Charles Rd. Maywood, IL 60153

**PHONE: 708-345-2075**

**FAX: 708-345-6490**

**WWW.LEWELECTRIC.COM**

**E-MAIL: sales@lewelectric.com**