

Wall Plates & Specialties

Pass & Seymour



Molded of rugged .065" thick polycarbonate.

Seamless, sleek, super smooth construction provides no dirt-catching channel around plate's perimeter.

SW26-W

.042" thick zinc-plated steel for ultimate strength and durability. Bridges recessed boxes and uneven sheet rock. Fixes floating installations.

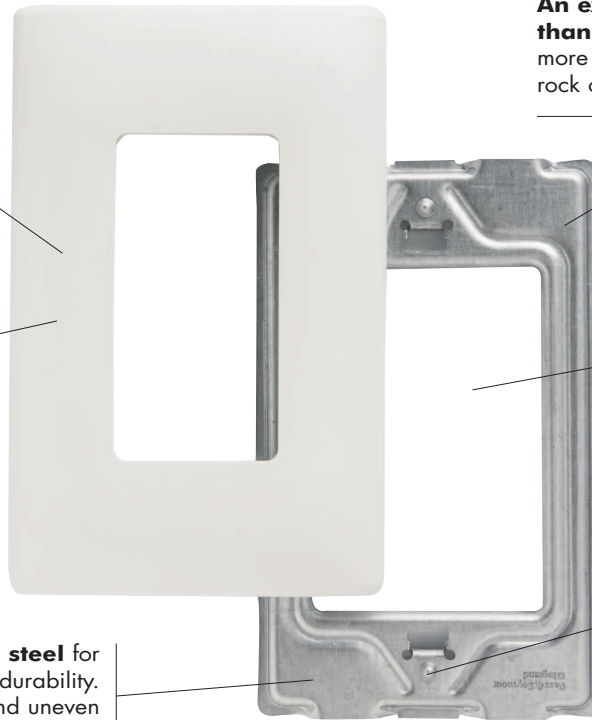

An extra 1/8" width and height than standard size wall plates for more tolerance in covering ragged sheet rock openings.

Oversized opening to accommodate all NEMA 26 decorator-style openings.

Automatic alignment pins ensure that devices are properly positioned so that wall plates fit perfectly.

Index

Style	Page Number
Specifications	S-2
Dimensions	S-3, S-4
Screwless Decorator Openings	S-5
Toggle Switch Openings	S-6
Duplex Receptacle Openings & Decorator Openings	S-7
Decorator Openings	S-8
Blank Plates	S-9, S-10
Single Receptacle Openings & Power Outlet Openings	S-11, S-12
Combination Openings	S-13 – S-16
Despard® Openings	S-17
Two Gang with Center Opening & Locking Switch Plates	S-18
Louver & Biplex/Triplex Openings	S-19
Junior-Jumbo & Jumbo Toggle, Duplex, Single Receptacle, Decorator, Blank & Combination Openings	S-20, S-22
Sectional Wall Plates	S-23
Tandem & Handy Box Plates	S-24
Narrow Metal	S-25
Dustproof Stainless Steel Covers	S-26
Communication Devices & Plates	S-27 – S-32
Mounting Straps, Yokes & Jewels	S-33
Decorator Hallway Lights & Combination Devices	S-34
Decorator Combination Nightlight/GFCI Receptacles	S-35
Incandescent Lampholders, Neon Pilot Lights & Panelites	S-36
Screws & Screwdrivers	S-37
Engraved & Pad Printed	S-38, S-39
Custom Metal Wall Plates	S-40 – S-42
Custom Panel Plates	S-43, S-44
Style Selector Guide	S-45 – S-57

Wall Plates Specifications



Thermoset SP Series



Nylon TP Series



Screwless Polycarbonate SW Series

Application

Pass & Seymour/Legrand's broad line of Standard Size Plastic and Metal Wall Plates features the most complete range of types, sizes, colors, and finishes available. Choose from more than 1,900 standard plates in non-combustible thermoset plastic material, self-extinguishing nylon material, screwless polycarbonate material, or attractively finished metal, for residential, commercial, institutional, and industrial applications. All plastic wall plates color match to Pass & Seymour/Legrand devices.

Thermoset Plastic Wall Plates Features

- Molded of non-combustible mar-proof material.
- Available in "SP" series in Standard, Junior-Jumbo, and Jumbo sizes.
- Seven standard colors available – Ivory, White, Brown, Gray, Black, Red, and Light Almond.
- Individually wrapped with color-matching screws.
- Resistant to discoloration, grease, oil, solvent and moisture.
- Nominal thickness, .070"

TradeMaster® Thermoplastic Wall Plates Features

- Molded of rugged, practically indestructible self-extinguishing nylon. ("TP" series only.)
- Available in "TP" series, extra 3/16" width and height than Standard size plates; and "TPJ" series, extra 3/16" width and height than Junior-Jumbo size plates.
- Available in Ivory, White, Brown, Gray, Black, Blue, Orange, Red, and Light Almond.
- Preferred for hospital, industrial, institutional, and other high-abuse applications.
- Nominal thickness, .070"

Screwless Polycarbonate Wall Plates Features

- Molded of .065" thick polycarbonate with matte finish.
- Subplate made of .042" zinc-plated steel.
- Available in "SW" series, extra 1/8" width and height than Standard size plates.
- Available in Ivory, White, Gray, Black, and Light Almond.
- Oversized opening to accommodate all NEMA 26 decorator-style openings.

Metal Wall Plates Features

- Constructed of corrosion-resistant stainless steel, brass, aluminum, chrome, brushed bronze or galvanized steel.
- Standard, Jumbo, and Tandem size plates available, as well as special Panel size plates up to 5-gangs high and 10-gangs wide.
- Packaged in protective film, with finish-matching screws.
- Variety of special plated finishes. Paintable to match plastic plates.
- Can be silk-screened or engraved, and custom punched with over 300 opening styles.

Materials

- Type 302 Stainless Steel, non-magnetic, .032" nominal thickness, brushed finish. This alloy contains 18% chromium and 8% nickel for superior resistance to corrosion. Recommended for use in food processing plants, dairies, chemical plants, and other industrial, institutional, and commercial applications where corrosive atmospheres exist.
- Type 430 Stainless Steel, magnetic, .032" nominal thickness, brushed finish. Less corrosion-resistant than Type 302, but ideal for general service in high abuse applications in industrial plants, commercial, and institutional buildings.
- Chrome, Brushed and Polished Brass, .040" thick. 70% copper, 30% zinc alloy gives warm, appealing finish to modern decor as well as retrofit applications. Lacquered to prevent corrosion.
- Aluminum, .040" thick. Lustrous satin finish. Lacquered to prevent corrosion.
- Galvanized Steel. Used only for Handy Box Plates.
- Brushed Bronze, .040" thick. 90% copper, 10% zinc. Lacquered to prevent corrosion.



302 Stainless Steel



Polished Brass



Brushed Brass



Aluminum

Wall Plates Specifications

Pass & Seymour



Standard Size Wall Plates					
<ul style="list-style-type: none"> Standard size wall plates for all applications. Best fit for surface mount boxes. 			<ul style="list-style-type: none"> Available in plastic and metal only. 		
Dimensions					
1 gang	2.75" x 4.5"	4 gang	8.125" x 4.5"	7 gang	13.62" x 4.5"
2 gang	4.56" x 4.5"	5 gang	10" x 4.5"	8 gang	15.44" x 4.5"
3 gang	6.375" x 4.5"	6 gang	11.812" x 4.5"		

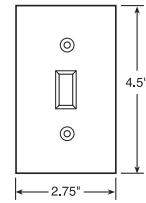

STANDARD

TradeMaster® Wall Plates					
<ul style="list-style-type: none"> Extra 3/16" width and height than Standard size wall plates. Provide better sheet rock coverage with standard size appearance. Available in unbreakable nylon 6 construction only. Screws pre-installed in the duplex, toggle, and decorator single gang plates. 					
Dimensions					
1 gang	2.9375" x 4.6875"	3 gang	6.563" x 4.6875"	5 gang	10.188" x 4.6875"
2 gang	4.75" x 4.6875"	4 gang	8.375" x 4.6875"	6 gang	12" x 4.6875"

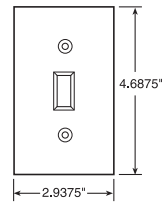

TRADEMASTER STANDARD

Screwless Polycarbonate Wall Plates					
<ul style="list-style-type: none"> Extra 1/8" width and height than Standard size wall plates. Provide better sheet rock coverage with standard size appearance. Molded of .065" thick polycarbonate. Subplate made of .042" zinc-plated steel. Oversized opening to accommodate all NEMA 26 decorator-style openings. 					
Wall Plate Dimensions					
1 gang	3.10" x 4.87"	3 gang	6.724" x 4.87"	5 gang	10.348" x 4.87"
2 gang	4.912" x 4.87"	4 gang	8.536" x 4.87"	6 gang	12.16" x 4.87"
Subplate Dimensions					
1 gang	2.85" x 4.62"	3 gang	6.474" x 4.62"	5 gang	10.098" x 4.62"
2 gang	4.662" x 4.62"	4 gang	8.286" x 4.62"	6 gang	11.910" x 4.62"

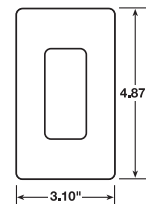

SCREWLESS

Junior-Jumbo Wall Plates					
<ul style="list-style-type: none"> Extra 3/8" width and height than Standard size wall plates. Additional coverage for sheet rock gaps. 			<ul style="list-style-type: none"> Available in plastic and metal only. 		
Dimensions					
1 gang	3.125" x 4.87"	3 gang	6.75" x 4.87"		
2 gang	4.93" x 4.87"	4 gang	8.56" x 4.87"		

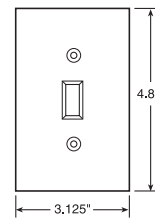

JUNIOR-JUMBO

TradeMaster Jumbo Wall Plates					
<ul style="list-style-type: none"> Extra 3/16" width and height than Junior-Jumbo size wall plates. Provide additional coverage for sheet rock gaps, matching the appearance of the TradeMaster Plates. Available in unbreakable nylon 6 construction only. Screws pre-installed in the duplex, toggle, and decorator single gang plates. 					
Dimensions					
1 gang	3.3125" x 5.0625"	3 gang	6.9375" x 5.0625"		
2 gang	5.125" x 5.0625"	4 gang	8.75" x 5.0625"		

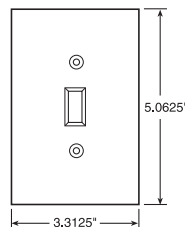

TRADEMASTER JUMBO

Jumbo Wall Plates					
<ul style="list-style-type: none"> Extra 3/4" width and height than Standard size wall plates. Largest size wall plates to cover larger wall damage. 			<ul style="list-style-type: none"> Available in plastic and metal only. 		
Dimensions					
1 gang	3.5" x 5.25"	3 gang	7.12" x 5.25"		
2 gang	5.31" x 5.25"	4 gang	8.93" x 5.25"		

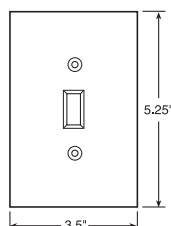

JUMBO

Wall Plates Dimensions

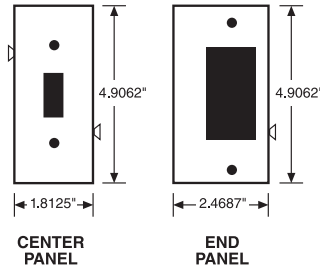

Sectional Wall Plates Features

- End and center panels with each of five most-used configurations make it possible to improvise custom wall plates on the job. Panels lock securely together on installation. Blank sections furnished with mounting strap.

Wall Plate Mountings

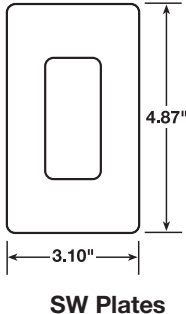
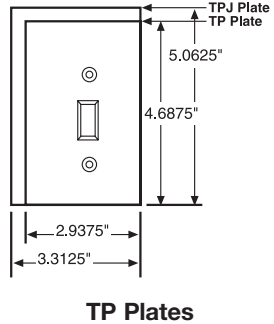
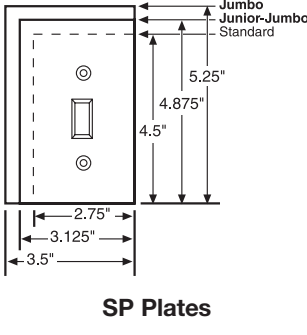
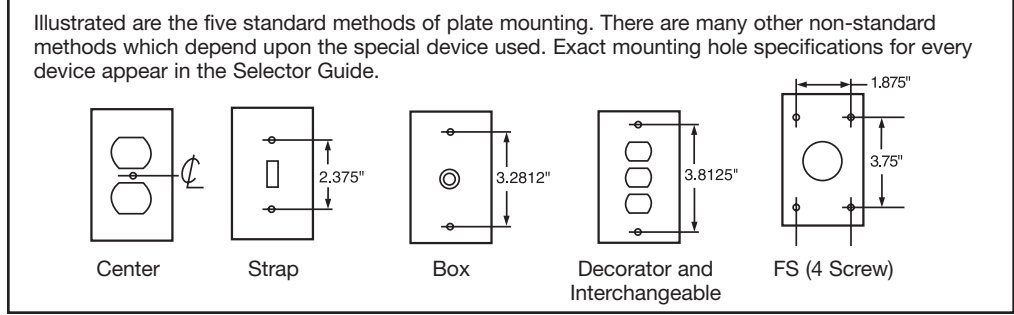

Wall Plate Sizes

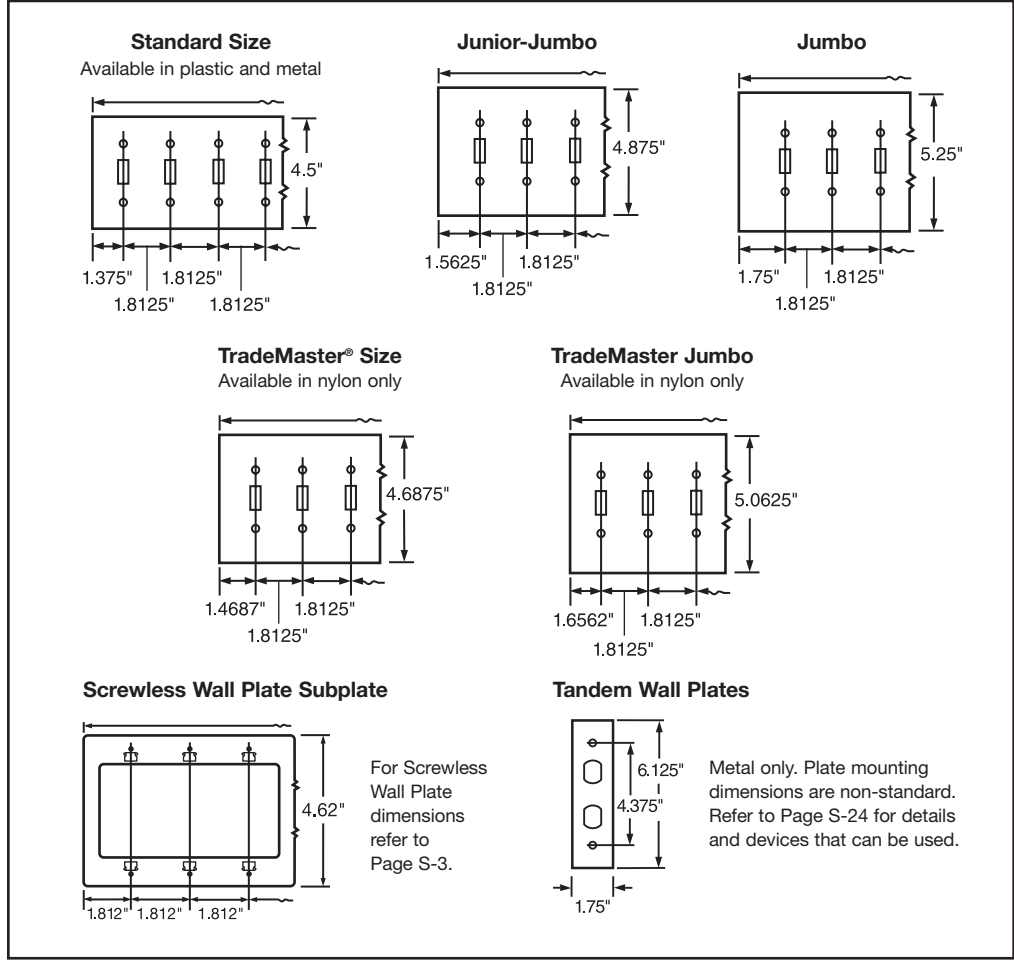

Wall Plates



Screwless Decorator Openings

Polycarbonate

Pass & Seymour

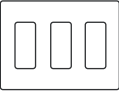
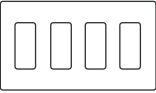
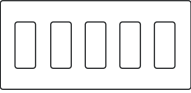
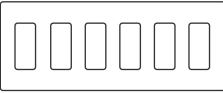

NEW

Description	Color	Polycarbonate
Screwless Decorator Openings — subplate included		
One Gang 	Ivory White Gray Black Light Almond	SW26-I SW26-W SW26-GRY SW26-BK SW26-LA
Two Gang 	Ivory White Gray Black Light Almond	SW262-I SW262-W SW262-GRY SW262-BK SW262-LA
Three Gang 	Ivory White Gray Black Light Almond	SW263-I SW263-W SW263-GRY SW263-BK SW263-LA
Four Gang 	Ivory White Gray Black Light Almond	SW264-I SW264-W SW264-GRY SW264-BK SW264-LA
Five Gang 	Ivory White Gray Black Light Almond	SW265-I SW265-W SW265-GRY SW265-BK SW265-LA
Six Gang 	Ivory White Gray Black Light Almond	SW266-I SW266-W SW266-GRY SW266-BK SW266-LA

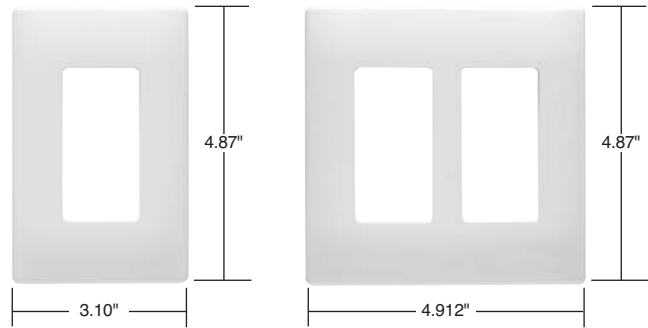

One Gang

Two Gang

Description	Height	Width
Screwless Wall Plate Dimensions		
One Gang	4.87"	3.10"
Two Gang	4.87"	4.912"
Three Gang	4.87"	6.724"
Four Gang	4.87"	8.536"
Five Gang	4.87"	10.348"
Six Gang	4.87"	12.16"

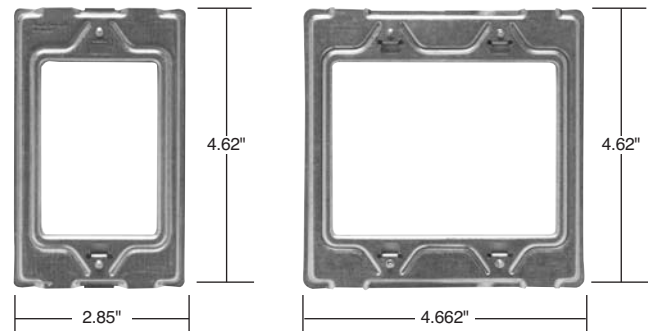









One Gang Subplate

Two Gang Subplate

Description	Height	Width
Screwless Subplate Dimensions		
One Gang	4.62"	2.85"
Two Gang	4.62"	4.662"
Three Gang	4.62"	6.474"
Four Gang	4.62"	8.286"
Five Gang	4.62"	10.098"
Six Gang	4.62"	11.910"

Wall Plates Toggle Switch Openings

Standard Size Plastic & Metal





Description	Color	Nylon	Thermoset	Metal	
		TradeMaster® Plates	Smooth	Material	Smooth
Toggle Switch Openings					
One Gang 	Ivory White Brown Gray Black Red Light Almond	TP1-I TP1-W TP1 TP1-GRY TP1-BK TP1-RED TP1-LA	SP1-I SP1-W SP1 SP1-GRY SP1-LA	Aluminum Brass Polished Brass 430S/S 302S/S Brushed Bronze Chrome	SA1 SB1 SB1-PB SL1 SS1 SB1-BZ SB1-CH
Two Gang 	Ivory White Brown Gray Black Red Light Almond	TP2-I TP2-W TP2 TP2-GRY TP2-BK TP2-RED TP2-LA	SP2-I SP2-W SP2 SP2-GRY SP2-LA	Aluminum Brass Polished Brass 430S/S 302S/S Brushed Bronze Chrome	SA2 SB2 SB2-PB SL2 SS2 SB2-BZ SB2-CH
Three Gang 	Ivory White Brown Gray Black Red Light Almond	TP3-I TP3-W TP3 TP3-GRY TP3-BK TP3-RED TP3-LA	SP3-I SP3-W SP3 SP3-GRY SP3-LA	Aluminum Brass Polished Brass 430S/S 302S/S Brushed Bronze Chrome	SA3 SB3 SB3-PB SL3 SS3 SB3-BZ SB3-CH
Four Gang 	Ivory White Brown Gray Black Red Light Almond	TP4-I TP4-W TP4 TP4-GRY TP4-BK TP4-RED TP4-LA	SP4-I SP4-W SP4 SP4-GRY SP4-LA	Aluminum Brass Polished Brass 430S/S 302S/S	SA4 SB4 SB4-PB SL4 SS4
Five Gang 	Ivory White Brown Gray Black Light Almond	TP5-I TP5-W TP5 TP5-GRY TP5-BK TP5-LA	SP5-I SP5-W SP5 SP5-GRY SP5-LA	Brass Polished Brass 302S/S	SB5 SB5-PB SS5
Six Gang 	Ivory White Brown Gray Black Light Almond	TP6-I TP6-W TP6 TP6-GRY TP6-BK TP6-LA	SP6-I SP6-W SP6-GRY SP6-LA	Polished Brass 302S/S	SB6-PB SS6
Seven Gang 				302S/S 302S/S Painted Ivory 302S/S Painted White	SS601 SS601-I SS601-W
Eight Gang 				302S/S 302S/S Painted Ivory 302S/S Painted White	SS602 SS602-I SS602-W

Duplex Receptacle & Decorator Openings

Standard Size Plastic & Metal



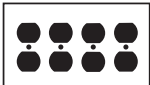
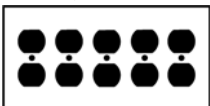
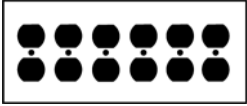



Pass & Seymour



Description	Color	Nylon	Thermoset	Metal	
		TradeMaster® Plates	Smooth	Material	Smooth
Duplex Receptacle Openings					
One Gang 	Ivory White Brown Gray Black Red Light Almond Blue Orange	TP8-I TP8-W TP8 TP8-GRY TP8-BK TP8-RED TP8-LA TP8-BL TP8-OR	SP8-I SP8-W SP8 SP8-GRY SP8-LA	Aluminum Brass Polished Brass 430S/S 302S/S Brushed Bronze Chrome	SA8 SB8 SB8-PB SL8 SS8 SB8-BZ SB8-CH
Two Gang 	Ivory White Brown Gray Black Red Light Almond Orange	TP82-I TP82-W TP82 TP82-GRY TP82-BK TP82-RED TP82-LA TP82-OR	SP82-I SP82-W SP82 SP82-GRY SP82-LA	Aluminum Brass Polished Brass 430S/S 302S/S Brushed Bronze Chrome	SA82 SB82 SB82-PB SL82 SS82 SB82-BZ SB82-CH
Three Gang 	Ivory White Brown Gray Light Almond		SP83-I SP83-W SP83 SP83-GRY SP83-LA	Brass Polished Brass 302S/S	SB83 SB83-PB SS83
Four Gang 	Ivory White Brown Gray		SP84-I SP84-W SP84 SP84-GRY	Polished Brass 302S/S	SB84-PB SS84
Five Gang 				302S/S	SS85
Six Gang 				302S/S	SS86
Decorator Openings					
One Gang 	Ivory White Brown Gray Black Red Light Almond Blue Orange	TP26-I TP26-W TP26 TP26-GRY TP26-BK TP26-RED TP26-LA TP26-BL TP26-OR	SP26-I SP26-W SP26 SP26-GRY SP26-BK SP26-LA	Aluminum Brass Polished Brass 430S/S 302S/S Brushed Bronze Chrome	SA26 SB26 SB26-PB SL26 SS26 SB26-BZ SB26-CH

Wall Plates Decorator Openings

Standard Size Plastic & Metal



Description	Color	Nylon	Thermoset	Metal	
		TradeMaster® Plates	Smooth	Material	Smooth
Decorator Openings					
Two Gang 	Ivory White Brown Gray Black Red Light Almond Blue Orange	TP262-I TP262-W TP262 TP262-GRY TP262-BK TP262-RED TP262-LA TP262-BL TP262-OR	SP262-I SP262-W SP262 SP262-GRY SP262-BK SP262-LA	Aluminum Brass Polished Brass 430S/S 302S/S	SA262 SB262 SB262-PB SL262 SS262
Three Gang 	Ivory White Brown Gray Black Red Light Almond	TP263-I TP263-W TP263 TP263-GRY TP263-BK TP263-RED TP263-LA	SP263-I SP263-W SP263-GRY SP263-BK SP263-LA	Brass Polished Brass 302S/S	SB263 SB263-PB SS263
Four Gang 	Ivory White Brown Gray Black Red Light Almond	TP264-I TP264-W TP264 TP264-GRY TP264-BK TP264-RED TP264-LA	SP264-I SP264-W SP264 SP264-GRY SP264-BK SP264-LA	Brass Polished Brass 302S/S	SB264 SB264-PB SS264
Five Gang 	Ivory White Brown Gray Black Red Light Almond	TP265-I TP265-W TP265 TP265-GRY TP265-BK TP265-LA	SP265-I SP265-W SP265-GRY SP265-BK SP265-RED SP265-LA	302S/S	SS265
Six Gang 	Ivory White Brown Gray Black Light Almond	TP266-I TP266-W TP266 TP266-GRY TP266-BK TP266-LA	SP266-I SP266-W SP266 SP266-GRY SP266-BK SP266-LA	302S/S	SS266
Seven Gang 				302S/S 302S/S Painted Ivory 302S/S Painted White	SS267 SS267-I SS267-W
Eight Gang 				302S/S 302S/S Painted Ivory 302S/S Painted White	SS268 SS268-I SS268-W

Wall Plates Blank Plates – Box Mounted

Standard Size Plastic & Metal

Pass & Seymour



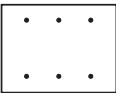
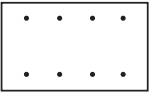
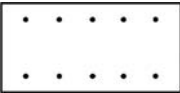
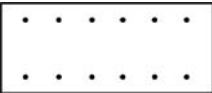
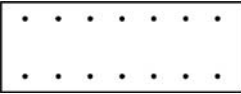
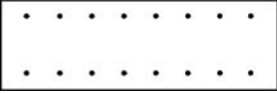

Description	Color	Nylon	Thermoset	Metal	
		TradeMaster® Plates	Smooth	Material	Smooth
Blank Plates – Box Mounted					
One Gang Blank – Box Mtd. 	Ivory White Brown Gray Black Red Light Almond	TP13-I TP13-W TP13 TP13-GRY TP13-BK TP13-RED TP13-LA	SP13-I SP13-W SP13 SP13-GRY SP13-LA	Aluminum Brass Polished Brass 430S/S 302S/S 302S/S (1/2" Screws) Brushed Bronze Chrome	SA13 SB13 SB13-PB SL13 SS13 SS13.5 SB13-BZ SB13-CH
Two Gang Blank – Box Mtd. 	Ivory White Brown Gray Black Light Almond	TP23-I TP23-W TP23 TP23-GRY TP23-BK TP23-LA	SP23-I SP23-W SP23 SP23-GRY SP23-LA	Aluminum Brass Polished Brass 430S/S 302S/S 302S/S (1/2" Screws) Brushed Bronze Chrome	SA23 SB23 SB23-PB SL23 SS23 SS23.5 SB23-BZ SB23-CH
Three Gang Blank – Box Mtd. 	Ivory White Brown Gray Light Almond		SP33-I SP33-W SP33 SP33-GRY SP33-LA	Polished Brass 302S/S 302S/S (1/2" Screws)	SB33-PB SS33 SS33.5
Four Gang Blank – Box Mtd. 	Ivory White Brown Gray		SP43-I SP43-W SP43 SP43-GRY	302S/S	SS43
Five Gang Blank – Box Mtd. 				302S/S	SS53
Six Gang Blank – Box Mtd. 				302S/S	SS63
Seven Gang Blank – Box Mtd. 				302S/S	SS6013
Eight Gang Blank – Box Mtd. 				302S/S	SS6023

Wall Plates

Blank Plates – Strap Mounted

Standard Size Plastic & Metal

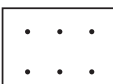
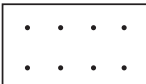
Description	Color	Nylon	Thermoset	Metal	
		TradeMaster® Plates	Smooth	Material	Smooth
Blank Plates – Strap Mounted with Adjustment Yoke					
One Gang Blank – Strap Mtd. 	Ivory White Brown Gray Black Red Light Almond	TP14-I TP14-W TP14 TP14-GRY TP14-BK TP14-LA	SP14-I SP14-W SP14 SP14-GRY SP14-BK SP14-RED SP14-LA	Aluminum Brass 430S/S 302S/S 302S/S (1/2" Screws)	SA14 SB14 SL14 SS14 SS14.5
Two Gang Blank – Strap Mtd. 	Ivory White Brown Gray Black Red Light Almond	TP24-I TP24-W TP24 TP24-GRY TP24-BK TP24-LA	SP24-I SP24-W SP24 SP24-GRY SP24-BK SP24-RED SP24-LA	Aluminum Brass 430S/S 302S/S 302S/S (1/2" Screws)	SA24 SB24 SL24 SS24 SS24.5
Three Gang Blank – Strap Mtd. 	Ivory White Brown Gray		SP34-I SP34-W SP34 SP34-GRY	302S/S	SS34
Four Gang Blank – Strap Mtd. 	Ivory White Brown Gray		SP44-I SP44-W SP44 SP44-GRY	302S/S	SS44









Wall Plates

Single Receptacle & Power Outlet Openings

Standard Size Plastic & Metal







Pass & Seymour



Description	Color	Nylon	Thermoset	Metal	
		TradeMaster® Plates	Smooth	Material	Smooth
Single Receptacle Openings					
One Gang 	Ivory White Brown Gray Black Red Light Almond	TP7-I TP7-W TP7 TP7-GRY TP7-BK TP7-RED TP7-LA	SP7-I SP7-W SP7 SP7-GRY SP7-LA	Aluminum Brass Polished Brass 430S/S 302S/S	SA7 SB7 SB7-PB SL7 SS7
Two Gang 	Ivory White Brown		SP72-I SP72-W SP72	302S/S	SS72
Three Gang 				302S/S 302S/S Painted Ivory 302S/S Painted White 302S/S Painted Gray	SS73 SS73-I SS73-W SS73-GRY
Power Outlet Receptacle Openings – One Gang					
 <p>1.5938" hole for 1.5625" dia. device – 2 mtg. holes</p>	Ivory White Brown Gray Light Almond	TP720-I TP720-W TP720 TP720-GRY TP720-LA	SP720-I SP720-W SP720 SP720-GRY SP720-LA	302S/S	SS720
 <p>1.625" hole for 1.5938" dia. device – 2 mtg. holes</p>				302S/S	SS721
 <p>1.75" hole for 1.7186" dia. device-2 mtg. holes</p>				302S/S	SS725
 <p>2.125" hole for 2.094" dia. device – 2 mtg. holes</p>				302S/S	SS723
 <p>2.156" hole for 2.125" dia. device – 2 mtg. holes</p>	Ivory White Brown Gray Black Light Almond	TP724-I TP724-W TP724 TP724-GRY TP724-BK TP724-LA	384-I 384	Chrome 302S/S	S384-C SS724

Wall Plates Power Outlet Receptacle Openings

Standard Size Plastic & Metal









Description	Color	Nylon	Thermoset	Metal	
		TradeMaster® Plates	Smooth	Material	Smooth
Power Outlet Receptacle Openings – Two Gang					
 2.4688" hole for 2.375" dia. device – 4 mtg. holes				Chrome 302S/S	S3863-C SS701
 2.1563" hole for 2.125" dia. device – 2 mtg. holes				302S/S	SS702
 2.1563" hole for 2.125" dia. device – 4 mtg. holes	Ivory Ivory White Brown Brown Gray Black Light Almond	TP703-I TP703-W TP703 TP703-GRY TP703-BK TP703-LA	SP703-I 3862-I SP703 3862 SP703-LA	Chrome 302S/S	S3862-C SS703
 2.2813" hole for 2.125" dia. device – 4 mtg. holes				Aluminum 302S/S	SA716 SS716
 2.1563" hole for 2.125" dia. device – 4 mtg. holes				302S/S	SS705
 1.5938" hole for 1.5625" dia. device – 2 mtg. holes				302S/S	SS710

Wall Plates Combination Openings

Standard Size Plastic & Metal





Pass & Seymour



Description	Color	Nylon	Thermoset	Metal	
		TradeMaster® Plates	Smooth	Material	Smooth
Toggle Switch & Duplex Receptacle Openings					
Two Gang 1 Toggle, 1 Duplex 	Ivory White Brown Gray Black Red Light Almond	TP18-I TP18-W TP18 TP18-GRY TP18-BK TP18-RED TP18-LA	SP18-I SP18-W SP18 SP18-GRY SP18-LA	Brass Polished Brass 302S/S	SB18 SB18-PB SS18
Three Gang 2 Toggles, 1 Duplex 	Ivory White Brown Gray Black Red Light Almond	TP28-I TP28-W TP28 TP28-GRY TP28-BK TP28-RED TP28-LA	SP28-I SP28-W SP28 SP28-GRY SP28-LA	Brass Polished Brass 302S/S	SB28 SB28-PB SS28
Four Gang 3 Toggles, 1 Duplex 	Ivory White Brown Gray Light Almond		SP38-I SP38-W SP38 SP38-GRY SP38-LA	Polished Brass 302S/S	SB38-PB SS38
Five Gang 4 Toggles, 1 Duplex 				302S/S 302S/S Painted Ivory 302S/S Painted White	SS48 SS48-I SS48-W
Toggle Switch & Decorator Openings					
Two Gang 1 Toggle, 1 Decorator 	Ivory White Brown Gray Black Light Almond	TP126-I TP126-W TP126 TP126-GRY TP126-BK TP126-LA	SP126-I SP126-W SP126 SP126-GRY SP126-BK SP126-LA	Aluminum Brass Polished Brass 302S/S	SA126 SB126 SB126-PB SS126
Three Gang 2 Toggles, 1 Decorator 	Ivory White Brown Gray Light Almond Black	TP226-I TP226-W TP226 TP226-GRY TP226-LA TP226-BK	SP226-I SP226-W SP226 SP226-GRY SP226-LA	302S/S	SS226
Three Gang 1 Toggle, 2 Decorator 	Ivory White Brown Gray Black Light Almond		SP1262-I SP1262-W SP1262 SP1262-GRY SP1262-BK SP1262-LA	302S/S	SS1262
Four Gang 3 Toggles, 1 Decorator 	Ivory White Brown Gray Light Almond		SP326-I SP326-W SP326 SP326-GRY SP326-LA	302S/S	SS326

Wall Plates Combination Openings

Standard Size Plastic & Metal









Description	Color	Nylon	Thermoset	Metal	
		TradeMaster® Plates	Smooth	Material	Smooth
Toggle Switch & Decorator Openings (cont.)					
Four Gang 2 Toggles, 2 Decorator 	Ivory White Brown Light Almond		SP2262-I SP2262-W SP2262 SP2262-LA		
Toggle Switch & Blank Strap Mounted Openings					
Two Gang 1 Toggle, 1 Blank 				302S/S	SS114
Three Gang 2 Toggles, 1 Blank 				302S/S	SS214
Four Gang 3 Toggles, 1 Blank 				302S/S	SS314

Wall Plates Combination Openings

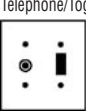
Standard Size Plastic & Metal

Pass & Seymour









Description	Color	Nylon	Thermoset	Metal	
		TradeMaster® Plates	Smooth	Material	Smooth
Two Gang Combination Openings					
Two Gang 1 Toggle, 1 Single 	Ivory White Brown Gray		SP17-I SP17-W SP17 SP17-GRY	302S/S	SS17
Two Gang Single/Duplex 	Ivory White Brown Gray		SP78-I SP78-W SP78 SP78-GRY	Aluminum 302S/S	SA78 SS78
Two Gang Duplex/Decorator 	Ivory White Brown Gray Black Red Light Almond	TP826-I TP826-W TP826 TP826-GRY TP826-BK TP826-RED TP826-LA	SP826-I SP826-W SP826 SP826-GRY SP826-LA	Polished Brass 302S/S	SB826-PB SS826
Two Gang Telephone/Toggle 	Ivory White Brown		SP112-I SP112-W SP112		
Two Gang Telephone/Duplex 	Ivory White Brown Gray		SP128-I SP128-W SP128 SP128-GRY	302S/S	SS128
Two Gang Telephone/Blank (Strap Mtd) 	Ivory White		SP1214-I SP1214-W	302S/S	SS1214
Two Gang Telephone/Decorator 	Ivory White Brown		SP1226-I SP1226-W SP1226	302S/S	SS1226
Two Gang Blank (Box Mtd)/Duplex 	Ivory White Brown Gray Black Red Light Almond	TP138-I TP138-W TP138 TP138-GRY TP138-BK TP138-RED TP138-LA	SP138-I SP138-W SP138 SP138-GRY	302S/S	SS138
Two Gang Toggle/Blank (Box Mtd) 	Ivory White Brown Gray Black Light Almond	TP113-I TP113-W TP113 TP113-GRY TP113-BK TP113-LA		302S/S	SS113

These products listed to UL514, Cover Plates for Flush-Mounted Wiring Devices, CSA Certified.

Wall Plates Combination Openings

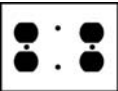
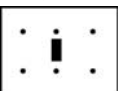
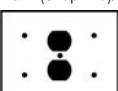
Standard Size Plastic & Metal

Description	Color	Nylon	Thermoset	Metal	
		TradeMaster® Plates	Smooth	Material	Smooth
Two Gang Combination Openings (cont.)					
Two Gang Blank (Strap Mtd)/Duplex 	Ivory White Brown Gray		SP148-I SP148-W SP148 SP148-GRY	302S/S	SS148
Two Gang Blank (Strap Mtd)/Single 	Ivory White		SP147-I SP147-W	302S/S	SS147
Two Gang Blank (Strap Mtd)/Decorator 	Ivory White Brown Gray Light Almond		SP1426-I SP1426-W SP1426 SP1426-GRY SP1426-LA	302S/S	SS1426
Three & Four Gang Combination Openings					
Three Gang Toggle/Duplex/Duplex 	Ivory White Brown Gray Light Almond		SP182-I SP182-W SP182 SP182-GRY SP182-LA	Polished Brass 302S/S	SB182-PB SS182
Three Gang Duplex/Blank (Strap Mtd)/Duplex 				302S/S	SS8148
Three Gang Blank (Strap Mtd)/Toggle/Blank (Strap Mtd) 				302S/S	SS14114
Three Gang Blank (Strap Mtd)/Duplex/Blank (Strap Mtd) 				302S/S	SS14814
Four Gang 2 Toggles, 2 Duplex 				302S/S	SS282









Wall Plates Despard® Openings

Standard Size Plastic & Metal

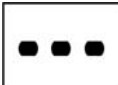
Despard Interchangeable Plate Supplied with Mounting Straps

Pass & Seymour







Description	Color	Nylon	Thermoset	Metal	
		TradeMaster® Plates	Smooth	Material	Smooth
One Horizontal Opening Per Gang					
One Gang 	Ivory White Brown		K1-I K1-W K1	302S/S	SSK1
Two Gang 				302S/S	SSK12
Three Gang 				302S/S	SSK13
Two Horizontal Openings Per Gang					
One Gang 	Ivory White Brown		K2-I K2-W K2	302S/S	SSK2
Two Gang 				302S/S	SSK22
Three Horizontal Openings Per Gang					
One Gang 	Ivory White Brown		K3-I K3-W K3	302S/S	SSK3
Two Gang 				302S/S	SSK32
Three Gang 				302S/S	SSK33
One Vertical Opening Per Gang					
One Gang 	Ivory White Brown		K4-I K4-W K4		



See Page T-11 for Devices.

Wall Plates

Two Gang with Center Opening

Standard Size Metal

Description	Color	Nylon	Thermoset	Metal	
		TradeMaster® Plates	Smooth	Material	Smooth
Two Gang with Center Opening					
Toggle Switch 				302S/S	SS740
Blank-Box Mount 				302S/S	SS743
Decorator 				302S/S	SS746
Single Receptacle 				302S/S	SS747
Duplex Receptacle 				302S/S	SS748





KL Series Locking Switch Plates					
One Gang  <p>.906 diameter Reference Page A-3 for device</p>				302S/S	SS717
Two Gang  <p>.906 diameter Reference Page A-3 for device</p>				302S/S	SS727

Wall Plates Louver & Biplx/Triplex Openings

Standard Size Metal

Pass & Seymour











Description	Color	Nylon	Thermoset	Metal	
		TradeMaster® Plates	Smooth	Material	Smooth
Louver Plates					
One Gang Horizontal 				Brass 302S/S 302S/S Painted Ivory 302S/S Painted White 302S/S Painted Light Almond	SB760 SS760 SS760-I SS760-W SS760-LA
One Gang Vertical 				Brass 302S/S 302S/S Painted Ivory 302S/S Painted White 302S/S Painted Brown 302S/S Painted Gray 302S/S Painted Light Almond	SB771 SS771 SS771-I SS771-W SS771-X SS771-GRY SS771-LA
Two Gang Vertical 				302S/S	SS772
Biplx/Triplex Receptacle					
One Gang 1 Biplx/Triplex 				302S/S	SS9

Pass & Seymour



Wall Plates Toggle Switch, Duplex & Single Receptacle Openings

Junior-Jumbo & Jumbo Plastic & Metal

Description	Color	Nylon	Thermoset		Metal		
		TradeMaster® Jumbo	Junior-Jumbo	Jumbo	Material	Junior-Jumbo	Jumbo
			Smooth	Smooth		Smooth	Smooth
Toggle Switch Openings							
One Gang 	Ivory White Brown Gray Light Almond	TPJ1-I TPJ1-W TPJ1 TPJ1-GRY TPJ1-LA	SPJ1-I SPJ1-W SPJ1 SPJ1-LA	SPO1-I SPO1-W SPO1	Brass 302S/S	SBJ1 SSJ1	SBO1 SSO1
Two Gang 	Ivory White Brown Gray Light Almond	TPJ2-I TPJ2-W TPJ2 TPJ2-GRY TPJ2-LA	SPJ2-I SPJ2-W SPJ2 SPJ2-LA	SPO2-I SPO2-W SPO2	Brass 302S/S	SBJ2 SSJ2	SSO2
Three Gang 	Ivory White Brown Gray Light Almond	TPJ3-I TPJ3-W TPJ3 TPJ3-GRY TPJ3-LA	SPJ3-I SPJ3-W SPJ3 SPJ3-LA		302S/S	SSJ3	SSO3
Four Gang 	Ivory White Brown Gray Light Almond	TPJ4-I TPJ4-W TPJ4 TPJ4-GRY TPJ4-LA	SPJ4-I SPJ4-W SPJ4 SPJ4-LA		302S/S		SSO4
Duplex Receptacle Openings							
One Gang 	Ivory White Brown Gray Light Almond	TPJ8-I TPJ8-W TPJ8 TPJ8-GRY TPJ8-LA	SPJ8-I SPJ8-W SPJ8 SPJ8-LA	SPO8-I SPO8-W SPO8 SPO8-LA	Brass 302S/S	SBJ8 SSJ8	SBO8 SSO8
Two Gang 	Ivory White Brown Gray Light Almond	TPJ82-I TPJ82-W TPJ82 TPJ82-GRY TPJ82-LA	SPJ82-I SPJ82-W SPJ82 SPJ82-GRY SPJ82-LA	SPO82-I SPO82-W SPO82	302S/S	SSJ82	SSO82
Three Gang 					302S/S		SSO83
Single Receptacle Openings							
One Gang 	Ivory White Brown Gray Light Almond	TPJ7-I TPJ7-W TPJ7 TPJ7-GRY TPJ7-LA	SPJ7-I SPJ7-W SPJ7 SPJ7-LA		302S/S	SSJ7	SSO7

Wall Plates Decorator Openings & Blank Plates

Junior-Jumbo & Jumbo Plastic & Metal

Pass & Seymour











Description	Color	Nylon	Thermoset		Metal		
		TradeMaster® Jumbo	Junior-Jumbo	Jumbo	Material	Junior-Jumbo	Jumbo
			Smooth	Smooth		Smooth	Smooth
Decorator Openings							
One Gang 	Ivory White Brown Gray Red Light Almond	TPJ26-I TPJ26-W TPJ26 TPJ26-GRY TPJ26-RED TPJ26-LA	SPJ26-I SPJ26-W SPJ26 SPJ26-LA	SPO26-I SPO26-W SPO26 SPO26-LA	Brass 302S/S	SBJ26 SSJ26	SB026 SS026
Two Gang 	Ivory White Brown Gray Light Almond	TPJ262-I TPJ262-W TPJ262 TPJ262-GRY TPJ262-LA	SPJ262-I SPJ262-W SPJ262 SPJ262-LA	SPO262-I SPO262-W SPO262	302S/S	SSJ262	SS0262
Three Gang 	Ivory White Brown Gray Light Almond	TPJ263-I TPJ263-W TPJ263 TPJ263-GRY TPJ263-LA	SPJ263-I SPJ263-W SPJ263 SPJ263-LA		302S/S	SSJ263	
Four Gang 	Ivory White Brown Gray Light Almond	TPJ264-I TPJ264-W TPJ264 TPJ264-GRY TPJ264-LA	SPJ264-I SPJ264-W SPJ264 SPJ264-LA				
Blank Plates – Box & Strap Mounted							
One Gang Blank – Box Mtd. 	Ivory White Brown Gray Light Almond	TPJ13-I TPJ13-W TPJ13 TPJ13-GRY TPJ13-LA	SPJ13-I SPJ13-W SPJ13 SPJ13-LA	SPO13-I SPO13-W SPO13	302S/S	SSJ13	SS013
Two Gang Blank – Box Mtd. 	Ivory White Brown			SPO23-I SPO23-W SPO23	302S/S		SS023
Three Gang Blank – Box Mtd. 					302S/S		SS033
One Gang Blank – Strap Mtd. 					302S/S		SS014
Two Gang Blank – Strap Mtd. 					302S/S		SS024
Three Gang Blank – Strap Mtd. 					302S/S		SS034





These products listed to UL514, Cover Plates for Flush-Mounted Wiring Devices, CSA Certified.

Wall Plates Combination Openings





Junior-Jumbo & Jumbo Plastic & Metal

Description	Color	Nylon	Thermoset		Metal		
		TradeMaster® Jumbo	Junior-Jumbo	Jumbo	Material	Junior-Jumbo	Jumbo
			Smooth	Smooth		Smooth	Smooth
Two Gang Combination Openings							
Two Gang Toggle/Duplex 	Ivory White Brown Gray Light Almond	TPJ18-I TPJ18-W TPJ18 TPJ18-GRY TPJ18-LA	SPJ18-I SPJ18-W SPJ18 SPJ18-LA	SPO18-I SPO18-W SPO18	302S/S	SSJ18	SSO18
Two Gang Toggle/Decorator 	Ivory White Brown Gray Light Almond	TPJ126-I TPJ126-W TPJ126 TPJ126-GRY TPJ126-LA	SPJ126-I SPJ126-W SPJ126 SPJ126-LA		302S/S	SSJ126	SSO126
Two Gang Toggle/Blank (Strap Mtd) Supplied with 340 Yoke 					302S/S		SSO114
Two Gang Toggle/Blank (Box Mtd) 	Ivory White Brown Gray Light Almond	TPJ113-I TPJ113-W TPJ113 TPJ113-GRY TPJ113-LA	SPJ113-I SPJ113-W SPJ113	SPO113-I SPO113			
Two Gang Blank (Box Mtd)/Duplex 	Ivory White Brown		SPJ138-I SPJ138-W SPJ138	SPO138-I SPO138	302S/S		SSO138
Two Gang Duplex/Decorator 	Ivory White Brown Gray Light Almond	TPJ826-I TPJ826-W TPJ826 TPJ826-GRY TPJ826-LA	SPJ826-I SPJ826-W SPJ826-LA				
Two Gang Blank/Decorator  ** strap mounted * box mounted	Ivory White Brown		SPJ1426-I** SPJ1426-W** SPJ1426**	SPO1326-I* SPO1326-W* SPO1326*			
Three Gang 2 Toggles/Duplex 					302S/S		SSO28

Thermoplastic

Description	Semi-Jumbo	
	Color	Smooth Nylon
Sectional Wall Plates – End Sections		
Toggle Switch 	Ivory White Light Almond	PJSE1-I PJSE1-W PJSE1-LA
Duplex Receptacle 	Ivory White Light Almond	PJSE8-I PJSE8-W PJSE8-LA
Single Receptacle 	Ivory White Light Almond	PJSE7-I PJSE7-W PJSE7-LA
Blank, Strap Mounted supplied with #340 Yoke 	Ivory White Light Almond	PJSE14-I PJSE14-W PJSE14-LA
Decorator 	Ivory White Light Almond	PJSE26-I PJSE26-W PJSE26-LA

Thermoplastic

Description	Semi-Jumbo	
	Color	Smooth Nylon
Sectional Wall Plates – Center Sections		
Toggle Switch 	Ivory White Light Almond	PJSC1-I PJSC1-W PJSC1-LA
Duplex Receptacle 	Ivory White Light Almond	PJSC8-I PJSC8-W PJSC8-LA
Single Receptacle 	Ivory White Light Almond	PJSC7-I PJSC7-W PJSC7-LA
Blank, Strap Mounted supplied with #340 Yoke 	Ivory White Light Almond	PJSC14-I PJSC14-W PJSC14-LA
Decorator 	Ivory White Light Almond	PJSC26-I PJSC26-W PJSC26-LA

3rd Party Compliance.
Reference Page S-4 for Features and Dimensions on Sectional Wall Plates.

Wall Plates Tandem & Handy Box Plates

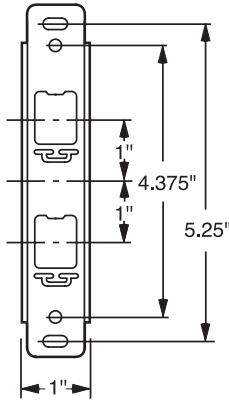

342 Strap





Features

- Tandem wall plates are ideal for curtain wall and movable partitions or wherever limited wiring exists.
- Note: Write factory for availability of other tandem sizes, materials, and openings.

Description	Material	Catalog Number
Tandem Wall Plates		
1-3/4" W x 6-1/8" H 2 Vertical Devices Supplied with #342 Strap	302S/S	SSTK-42-4

Features

- Handy Box Plates give a finished appearance and style to surface mounted boxes.
- Plate conceals rough edge of box.
- Available in the five most-used openings, they have a bright corrosion-resistant zinc-plated finish.

















Description	Material	Catalog Number
Galvanized Steel Handy Box Plates		
One Gang Toggle Switch 	Plated	SH1
One Gang Single Receptacle 	Plated	SH7
One Gang Duplex Receptacle 	Plated	SH8
One Gang Blank (Box Mounted) 	Plated	SH13
One Gang Decorator/GFCI 	Plated	SH26

Wall Plates Narrow Metal

Made to Order – Consult factory for price and availability

Pass & Seymour



Made to Order Wall Plates							
		1-3/8"	1-1/2"	1-11/16"	1-3/4"	2"	2-1/2"
Description	Material	Catalog Numbers					
 Toggle Switch	Aluminum 302S/S	SAN11 SSN11			SAN14 SSN14	SSN15	
 Telephone Outlet 13/32" Hole – Box Mounted	302S/S						SSN117
 Telephone Outlet 13/32" Hole – Strap Mounted	302S/S	SSN121					
 Blank Strap Mounted, 1 #340 Yoke	Aluminum 302S/S		SSN142		SAN144 SSN144		
 Duplex Receptacle	Aluminum 302S/S					SAN85 SSN85	
 1 Despard® Interchangeable Horizontal Opening Supplied With #348 Mounting Strap	Aluminum 302S/S				SANK14 SSNK14		
 2 Despard Interchangeable Horizontal Openings Supplied With #348 Mounting Strap	Aluminum 302S/S				SANK24 SSNK24		
 3 Despard Interchangeable Horizontal Openings Supplied With #348 Mounting Strap	302S/S				SSNK34		
 1 Despard Interchangeable Vertical Opening Supplied With #347 Mounting Strap	Aluminum 302S/S	SANK41 SSNK41		SANK43 SSNK43	SANK44 SSNK44		
 1 Despard Interchangeable Vertical Opening Device Mounted Use with #347 Strap	Aluminum 302S/S	SANK51 SSNK51		SANK53 SSNK53	SANK54 SSNK54		

Note: All narrow plates are 4-1/2" high.

Pass & Seymour



Wall Plates Dustproof Stainless Steel Covers

Specification Grade

Stainless Steel Covers are dustproof only and do not meet NEC 406.8(A) or (B).

Features	
<ul style="list-style-type: none"> Exclusive – Spec-grade stainless steel dust covers. Ideal for hard-use and corrosive applications. 	<ul style="list-style-type: none"> Aesthetically pleasing.

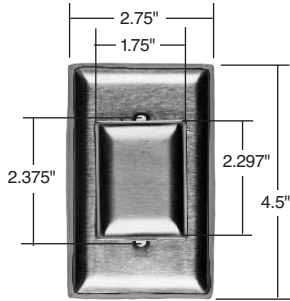

WP1
WP7

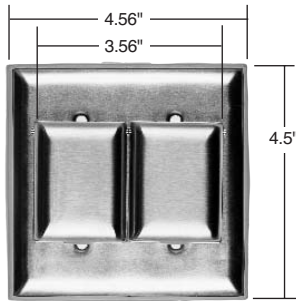

WP2

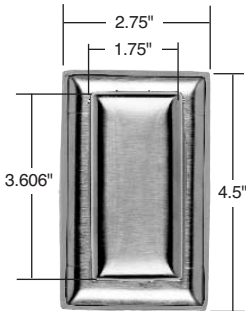

WP8
WP26

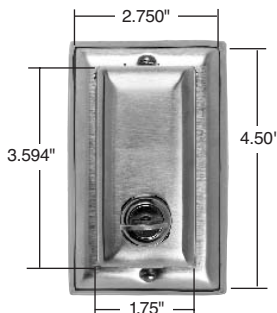

WP26-L

Catalog Number	Description	3rd Party Compliance	
		UL	SP
Dustproof Stainless Steel Covers			
	WP1 1 Toggle Switch 1 Small Cover, Vertical 1 Gang Plate Available for Four Screw Mount – add suffix -FS	•	•
	WP2 2 Toggle Switches 2 Small Covers, Vertical 2 Gang Plate	•	•
	WP7 1 Single Receptacle 1 Small Cover, Vertical 1 Gang Plate Available for Four Screw Mount – add suffix -FS	•	•
	WP8 1 Duplex Receptacle 1 Long Cover, Vertical 1 Gang Plate	•	•
	WPH8 1 Duplex Receptacle 1 Long Cover, Horizontal 1 Gang Plate	•	•
	WPD8 1 Duplex Receptacle 2 Small Covers, Horizontal 1 Gang Plate	•	•
	WP26 1 Decorator/GFCI 1 Long Cover, Vertical 1 Gang Plate	•	•
	WPH26 1 Decorator/GFCI 1 Long Cover, Horizontal 1 Gang Plate	•	•
Dustproof Locking Stainless Steel Covers			
	WP1-L Toggle Opening Horizontal	•	•
	WP7-L Single Receptacle Opening Horizontal	•	•
	WPH8-L Duplex Receptacle Opening Horizontal	•	•
	WP26-L Decorator/GFCI Vertical	•	•

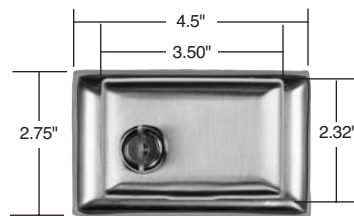

WPH1-L, WPH7-L

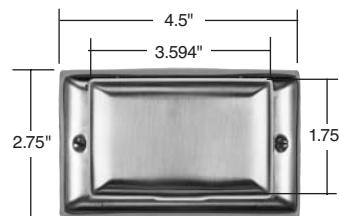

WPH8, WPH26

Catalog Number WP255-K.
Replacement key for all
Dustproof Locking Covers.
(Two keys furnished with
each unit.)

**Note: All locks
keyed the same.**

For Weatherproof Stainless Steel Covers, see Page R-13.

Wall Plates Communication Devices

Telephone Wiring Devices

Pass & Seymour



Features	
<ul style="list-style-type: none"> ■ RJ-11 modular jack. ■ Mar-resistant wall plate. ■ Wall plate dimension is Standard size. 	<ul style="list-style-type: none"> ■ Fits standard size single gang electrical box. ■ Meets FCC Part 68 requirements.

Catalog Number	Color	Configuration	3rd Party Compliance
			UL UL1863
Single Gang Opening Modular Telephone Jack with Wall Plate			
TPTE1-I	Ivory	4 Conductor	
TPTE1-W	White	4 Conductor	
TPTE1	Brown	4 Conductor	
TPTE1-GRY	Gray	4 Conductor	
TPTE1-BK	Black	4 Conductor	
TPTE1-LA	Light Almond	4 Conductor	
Single Gang, Two Modular RJ-11 Telephone Jacks with Wall Plate			
TPTE2-I	Ivory	4 Conductor	
TPTE2-W	White	4 Conductor	
TPTE2	Brown	4 Conductor	
TPTE2-BK	Black	4 Conductor	
TPTE2-LA	Light Almond	4 Conductor	

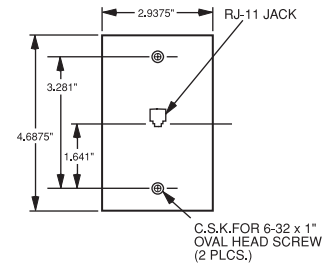

TPTE1

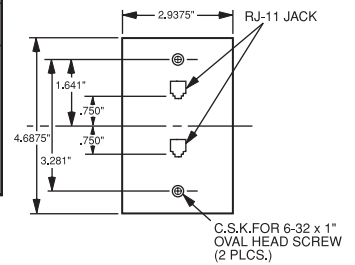

TPTE2

Features	
<ul style="list-style-type: none"> ■ Decorator-style rectangular design. ■ RJ-11 modular jack. ■ Fits standard single gang electrical box. ■ May be used in multigang applications. 	<ul style="list-style-type: none"> ■ Face constructed of high-impact thermoplastic. ■ Brass terminals with nickel-plated steel screws and washers. ■ Meets FCC Part 68 requirements.

Catalog Number	Color	Configuration	3rd Party Compliance
			UL UL1863
Decorator Modular Jack			
Single Gang, 1 Opening Modular Jack			
26TE14-I	Ivory	4 Conductor	•
26TE14-W	White	4 Conductor	
26TE14-LA	Light Almond	4 Conductor	
26TE16-I	Ivory	6 Conductor	•
26TE16-W	White	6 Conductor	

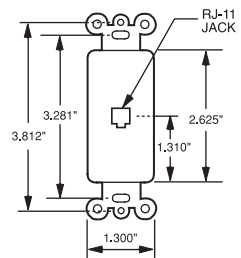

26TE14
26TE16

Wall Plates Communication Devices

Telephone Wiring Devices

Features

- One piece molded plate Decorator outline.
- Two RJ-11 modular jacks.
- Fits standard single gang electrical box.
- Face constructed of high-impact thermoplastic.
- Brass terminals with nickel-plated steel screws and washers.
- Wall plate dimension is standard size.
- Meets FCC Part 68 requirements.

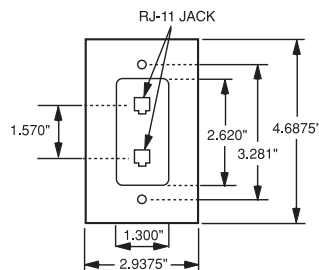

26TE24

Catalog Number	Color	Configuration	3rd Party Compliance
			UL UL1863
Decorator Duplex Modular Jack with Smooth Plate			
Single Gang, 2 Openings			
26TE24-I	Ivory	4 Conductor	•
26TE24-W	White	4 Conductor	•
26TE24-LA	Light Almond	4 Conductor	•
26TE26-I	Ivory	6 Conductor	•
26TE26-W	White	6 Conductor	•

Features

- RJ-11 modular jack.
- High-impact thermoplastic face plate and back body.
- Nickel-plated steel screw terminals.
- Zinc-plated mounting lugs.

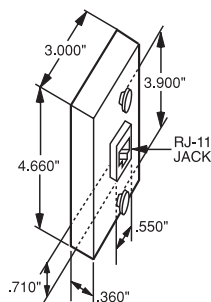

WMTE14

Catalog Number	Color	Configuration	3rd Party Compliance
			UL UL1863
Modular Wall Mount Telephone Jack for Hanging Phones			
WMTE14-I	Ivory	4 Conductor	•
WMTE14-W	White	4 Conductor	•
WMTE14-LA	Light Almond	4 Conductor	•

Features

- Nickel-plated steel screws and washers.
- Brass terminals.
- Comes with mounting screws and adhesive pad.
- Snap-on cover and base constructed of high-impact thermoplastic.

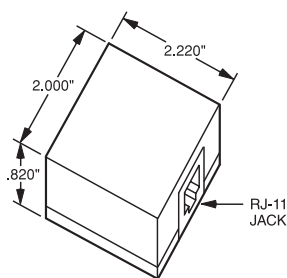

SMTE14

Catalog Number	Color	Configuration	3rd Party Compliance
			UL UL1863
Surface Mount Modular RJ-11 Telephone Jack			
SMTE14-I	Ivory	4 Conductor	•

Wall Plates Communication Devices

Telephone & CATV Wiring Devices

Pass & Seymour



Features	
<ul style="list-style-type: none"> Mar-resistant wall plate. Fits standard size single gang electrical box. Wall plate dimension is Standard size. 	<ul style="list-style-type: none"> Nickel-plated steel. Connector is threaded at each end.

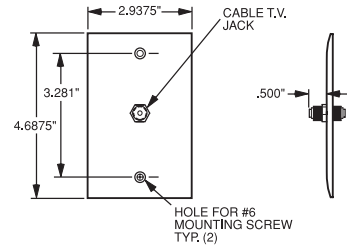

TPCATV

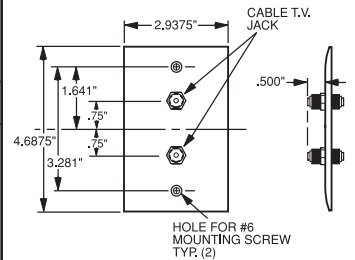

TPCATV2

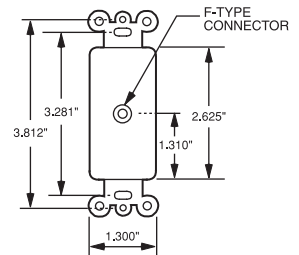

26CATV

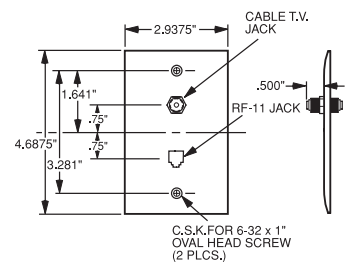

TPTELTV

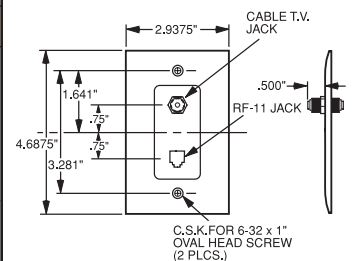

26TELTV

Catalog Number	Color	Configuration	3rd Party Compliance	
			UL	UL1863
"F" Type with One Coaxial Connector & Wall Plate, Single Gang				
TPCATV-I	Ivory	F-type COAX Connector		•
TPCATV-W	White	F-type COAX Connector		•
TPCATV	Brown	F-type COAX Connector		•
TPCATV-BK	Black	F-type COAX Connector		•
TPCATV-LA	Light Almond	F-type COAX Connector		•
"F" Type with Two Coaxial Connectors & Wall Plate, Single Gang				
TPCATV2-I	Ivory	2 F-type COAX Connectors		•
TPCATV2-W	White	2 F-type COAX Connectors		•
TPCATV2	Brown	2 F-type COAX Connectors		•
TPCATV2-BK	Black	2 F-type COAX Connectors		•
TPCATV2-LA	Light Almond	2 F-type COAX Connectors		•

Features	
<ul style="list-style-type: none"> Decorator outline. Face constructed of high-impact thermoplastic. Zinc-plated steel strap. 	<ul style="list-style-type: none"> Nickel-plated "F" type connector. Threaded on each end.

Catalog Number	Color	Configuration	3rd Party Compliance	
			UL	UL1863
Decorator "F" Type Coaxial Connector				
Single Gang with 1 COAX Connector				
26CATV-I	Ivory	F-type COAX Connector		•
26CATV-W	White	F-type COAX Connector		•
26CATV-LA	Light Almond	F-type COAX Connector		•

Features	
<ul style="list-style-type: none"> Decorator outline. RJ-11 modular jack. Face constructed of high-impact thermoplastic. 	<ul style="list-style-type: none"> Zinc-plated steel strap. Nickel-plated "F" type connector. Threaded on each end.

Catalog Number	Color	Configuration	3rd Party Compliance	
			UL	UL1863
Combination Coaxial Connector & Telephone Jack				
TPTELTV-I	Ivory	F-type COAX Connector with 4 Conductor RJ-11 jack		•
TPTELTV-W	White			•
TPTELTV	Brown			•
TPTELTV-BK	Black			•
TPTELTV-LA	Light Almond			•
26TELTV-ICC	Ivory	Same as TPTELTV with		•
26TELTV-WCC	White	one-piece molded plate		•
26TELTV-LACC	Light Almond	Decorator outline.		•

These products listed to UL514, Cover Plates for Flush-Mounted Wiring Devices, CSA Certified.

Wall Plates Communication Plates

Standard Size Plastic & Metal







Description	Color	Nylon	Thermoset	Metal	
		TradeMaster® Plates	Smooth	Material	Smooth
Telephone or Cable Outlet 13/32" Hole, Box Mounted					
<p>One Gang 1 Outlet</p> <p>(Metal plates have removable 13/32" I.D. grommet in 17/32" hole.)</p>	Ivory White Brown Gray Black Red Light Almond	TP11-I TP11-W TP11 TP11-GRY TP11-BK TP11-RED TP11-LA	SP11-I SP11-W SP11	Brass 302S/S	SB11 SS11
<p>Two Gang 2 Outlets</p>	Ivory White Gray		SP21-I SP21-W SP21-GRY	302S/S	SS21
Telephone or Cable Outlet 13/32" Hole, Strap Mounted, With Adjustment Yoke					
<p>One Gang 1 Outlet 1 #340 Yoke</p> <p>(Metal plates have removable 13/32" I.D. grommet in 17/32" hole.)</p>	Ivory White Brown Gray Black Red Light Almond	TP12-I TP12-W TP12 TP12-GRY TP12-BK TP12-LA	SP12-I SP12-W SP12 SP12-BK SP12-RED SP12-LA	Brass 430S/S 302S/S	SB12 SL12 SS12
<p>Two Gang 2 Outlets</p>				302S/S 302S/S Painted Ivory 302S/S Painted White 302S/S Painted Gray	SS22 SS22-I SS22-W SS22-GRY
Telephone or Cable Outlet 5/8" Hole, Strap Mounted					
<p>One Gang 1 Outlet 1 #340 Yoke</p> <p>(Metal plates have removable 5/8" I.D. grommet in 7/8" hole.)</p>				302S/S	SS730
Telephone or Cable Outlet 13/32" Hole With Knockout, Strap Mounted					
<p>One Gang 1 Outlet 1 #340 Yoke</p>	Ivory White Brown Gray		SP732-I SP732-W SP732 SP732-GRY		
Telephone or Cable Outlet 5/8" ID, Box Mounted					
<p>One Gang 1 Outlet</p>	Ivory White Light Almond	TP60-I TP60-W TP60-LA			
Telephone or Cable Outlet 1-1/4" Hole, Strap Mounted					
<p>One Gang 1 Outlet Supplied With #340 Yoke</p>				302S/S	SS736



Wall Plates Communication Plates

Pass & Seymour



Description	Metal	
	Material	Smooth
Horizontal-Split Wall Plates for Television or Cable Lead-In*		
 <p>One Gang 1 Outlet</p> <p>Box Mounted. Removable 13/32" I.D. grommet in 1/2" hole.</p>	302S/S	SS751
 <p>One Gang 1 Outlet Supplied With #340 Yoke</p> <p>Strap Mounted. Removable 13/32" I.D. grommet in 17/32" hole.</p>	302S/S	SS752
 <p>One Gang 1 Outlet</p> <p>Box Mounted. Removable 5/8" I.D. grommet in 7/8" hole.</p>	302S/S	SS753
 <p>One Gang 1 Outlet Supplied With #340 Yoke</p> <p>Strap Mounted. Removable 5/8" I.D. grommet in 7/8" hole.</p>	302S/S	SS754
 <p>Two Gang 1 Centered Outlet</p> <p>(Also Furnished for Strap Mounting Cat. # SS786 with 2 #340 Yokes. Box Mounted. Removable 13/32" I.D. grommet in 17/32" hole.)</p>	302S/S**	SS785
 <p>Two Gang 1 Centered Outlet</p> <p>(Also Furnished for Strap Mounting Cat. # SS788 with 2 #340 Yokes. Box Mounted. Removable 5/8" I.D. grommet in 7/8" hole.)</p>	302S/S**	SS787

* For telephone, security systems, FM and cable TV antennas or wherever cable interconnections are required.

** Strap Mounted with 2 #340 Yokes.

Wall Plates Communication Plates

Description	Thermoset		Metal	
	Color	Smooth	Material	Smooth
Two Gang with Centered Openings**				
1 Centered Outlet Box Mounted			302S/S	SS741
1 Centered Outlet Strap Mounted Supplied with #340 Yoke			302S/S	SS742
Computer Jack Plates for RS-232 Connectors**				
One Gang One Jack Opening			302S/S	SS791
One Gang Two Jack Opening			302S/S	SS792
Standard Combination Two Gang*				
Two Gang Telephone/Duplex	Ivory White Brown Gray	SP128-I SP128-W SP128 SP128-GRY	302S/S	SS128
Two Gang Telephone/Blank (Strap Mtd)	Ivory White	SP1214-I SP1214-W	302S/S	SS1214
Two Gang Telephone/Decorator	Ivory White Brown	SP1226-I SP1226-W SP1226	302S/S	SS1226
Two Gang Telephone/Toggle	Ivory White Brown	SP112-I SP112-W SP112		

* Has 13/32" and 5/8" double knockout.

Description	Thermoset		Metal	
	Junior-Jumbo		Jumbo	
	Color	Smooth	Material	Smooth
Telephone/Cable Outlet**				
One Gang 1 Outlet (Metal plates have removable 13/32" I.D. grommet in 17/32" hole.)	Ivory White Brown Light Almond	SPJ11-I SPJ11-W SPJ11 SPJ11-LA	302S/S	SS011
Telephone/Cable Outlet**				
One Gang 1 Outlet Supplied with #340 Yoke			302S/S	SS012

**These products listed to UL514, Cover Plates for Flush-Mounted Wiring Devices, CSA Certified.

Specialties Mounting Straps, Yokes & Jewels

Pass & Seymour



Description	Finish	Color	Catalog Number	Dimensions
Mounting Straps & Yokes				
Mounting strap for dimmer insert. Box mounted. Change from decorator to toggle opening.	Painted Steel	Ivory White Brown Light Almond	327-I 327-W 327 327-LA	
Mounting strap for blank insert. Box mounted. Changes decorator opening to blank.	Painted Steel	Ivory White Brown Light Almond	326-I 326-W 326 326-LA	
Tandem mounting strap with two vertical openings. Plate screw hole spacing 4-3/8".	Bright Zinc		342	
Mounting strap with three horizontal openings. Plate screw hole spacing 3-13/16". Box mounted.	Bright Zinc		348	
Mounting strap with single vertical opening. Plate screw hole spacing 3-13/16". Box mounted.	Bright Zinc		347	
Adjustment yoke for strap mounted telephone and blank wall plates. Slots 3-9/32" C to C. Plate screw holes 2-3/8" C to C. Box mounted.	Bright Zinc		340	
Mounting strap for blank insert. Changes toggle opening to blank, box mounted.	Thermoset	Ivory White Light Almond	80700-I 80700-W 80700-LA	

Description	Jewel Color	Catalog Number	Jewels		Jewels Shown with Wall Plates
			Front View	Side View	
Plastic Jewels – For Toggle Switch Openings (Style #1)					
Rectangular acrylic plastic warning light jewel for toggle switch plates with holding ring. Red Jewel Standard.	Red Green White	406-RED 406-GN 406-W			
Plastic Jewels – For Single Receptacle Openings (Style #7)					
Round acrylic plastic warning light jewel for single receptacle plates with holding ring. Red Jewel Standard.	Red Green White	405-RED 405-GN 405-W			

UL Listed.

Pass & Seymour

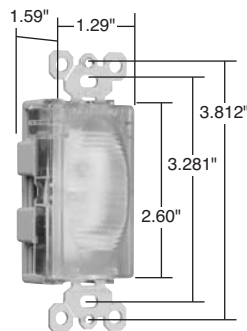

TMHWL-CC

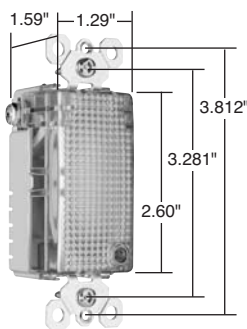

TMHWL-ECC

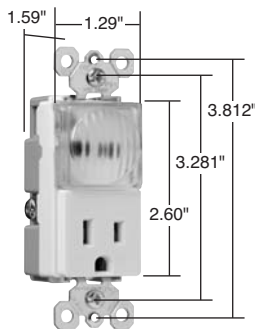

TM8HWL-WCC

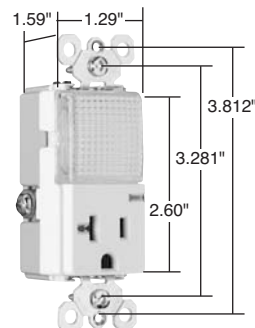

PS8HWL-LA

Specialties Decorator Hallway Lights & Combination Devices

Features

- Impact-resistant face and body.
 - GE Lexan™ high impact-resistant lens.
 - External screw-pressure-plate back and side wired. Accepts #12 and #14 AWG.
 - Ground screw position under the end of the strap minimizes the risk of contact.
 - Energy-efficient LED has average 20-year life expectancy: eliminates bulb replacement.
 - Sensor automatically turns light ON in the dark.
 - Increased light output for better illumination.
 - Light sensor for enhanced sensitivity.
- Tamper-Resistant Combination Version:*
- UL tested shutter mechanism for protection against improper object insertion per UL478.
 - Specially designed for increased protection of children in their homes.
 - Superior protection than traditional outlet “caps” or “protection plates.”

Catalog Number	Rating A. VAC	Light Output In 1' FCD*	Color	3rd Party Compliance	
				cUL US UL1598	
TradeMaster® Decorator Full Hallway Light					
TMHWL-CC	— 120	0.1328	Clear	•	
Enhanced Decorator Full Hallway Light with Light Sensor					
TMHWL-ECC	— 120	1.079	Clear	•	
Enhanced Decorator Full Hallway Light without Light Sensor					
TMHWL-ENSCC	— 120	1.113	Clear	•	
Full Hallway Decorator Light for use with P&S Metal Louver Plates**					
TMHWL-LOUVCC	— 120	0.0843	Clear	•	

*FCD = Foot Candle Distance, 1 Lumen = 1 FCD. See page U-42 for more information.

**For Louver Plates, see Page S-19.

Catalog Number	Rating A. VAC	Light Output In 1' FCD*	Color	NEMA Config. No.	3rd Party Compliance	
					cUL US UL498	
TradeMaster® Decorator Hallway Light & Single Receptacle						
TM8HWL-ICC	15 120/125	0.1442	Ivory	5-15R	•	
TM8HWL-WCC	15 120/125	0.1442	White	5-15R	•	
TM8HWL-BKCC	15 120/125	0.1442	Black	5-15R	•	
TM8HWL-CC	15 120/125	0.1442	Brown	5-15R	•	
TM8HWL-LACC	15 120/125	0.1442	Light Almond	5-15R	•	
Enhanced Decorator Hallway Light & Single Receptacle						
TM8HWL-EICC	15 120/125	0.2561	Ivory	5-15R	•	
TM8HWL-EWCC	15 120/125	0.2561	White	5-15R	•	
TM8HWL-ELACC	15 120/125	0.2561	Light Almond	5-15R	•	
Specification Grade Enhanced Decorator Hallway Light & Single Receptacle						
PS8HWL-I	20 120/125	0.2561	Ivory	5-20R	•	
PS8HWL-W	20 120/125	0.2561	White	5-20R	•	
PS8HWL-LA	20 120/125	0.2561	Light Almond	5-20R	•	
TradeMaster® Enhanced Decorator Hallway Light & Tamper-Resistant Single Receptacle						
TM8HWLTR-ICC	15 120/125	0.2561	Ivory	5-15R	•	
TM8HWLTR-WCC	15 120/125	0.2561	White	5-15R	•	
TM8HWLTR-BKCC	15 120/125	0.2561	Black	5-15R	•	
TM8HWLTR-CC	15 120/125	0.2561	Brown	5-15R	•	
TM8HWLTR-LACC	15 120/125	0.2561	Light Almond	5-15R	•	

*FCD = Foot Candle Distance. 1 Lumen = 1 FCD. See page U-42 for more information.

For complete line of Decorator Combination Devices, see Pages D-6 – D-10, D-17, D-19, D-25, and D-26.

All devices listed on this page conform to NEMA WD-1 and WD-6.

Specialties Decorator Combination Nightlight/GFCI Receptacles

15 & 20A, 125VAC

Pass & Seymour

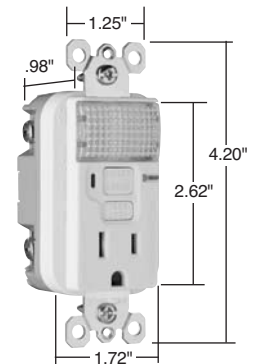

1595-NTLWCC6

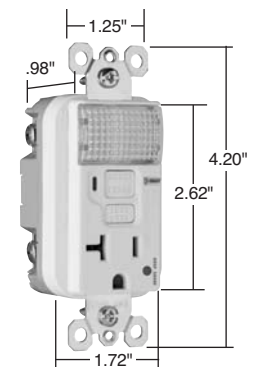

2095-HGNTLW

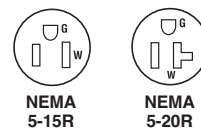

**NEMA
5-15R**

**NEMA
5-20R**

Features

- Meets 2006 UL requirements.
- SafeLock™ Protection: if critical components are damaged and ground fault protection is lost, power to receptacle is disconnected.
- Sealed nightlight with high impact-resistant Lexan® lens prevents tampering.
- Nightlight uses cooler LED illumination.
- Energy-efficient LED has average 20-year life expectancy, eliminating bulb replacement.
- Photocell turns nightlight ON in dark, OFF in daylight.
- Prevents line-load reversal miswire: no power to the face or downstream receptacles if wired incorrectly.
- Exceeds UL943 voltage surge requirements; survives 100x the required UL 3kA/6kV voltage surge test cycles.
- FSUL Listed (Federal Specification WC596).
- Trip indicator light (red lamp).
- Side or internal screw-pressure-plate back wire with #10 – #14 AWG solid or stranded copper wire.
- Two back wire holes per terminal.
- Ground screw has a back wire clamp for easy installation.
- 1/4" thinner than competitors' GFCIs; leaves more room for wires in the box.
- Mounting screws are shipped captive in the device and wall plate for easier installation.
- High-impact-resistant thermoplastic construction.
- Extra-long strap.
- Button colors match the device face.
- Dual-direction test and reset buttons.
- Class A rated GFCI.
- Supplied with matching TP26 nylon wall plate.
- Tri-drive screws.

Specifications

- Supply Voltage: 125VAC, 60 Hz
- Supply Voltage Range: 102-132 VAC
- Trip Threshold: 5± 1mA
- Trip Time: 0.025 sec., nominal per UL Standard
- 20 Amp feed-thru capacity

Catalog Number	Rating A.	VAC	Light Output in 1' FCD*	Color	NEMA Config. No.	3rd Party Compliance		
						UL943 C22.2 No. 144	UL498 C22.2 No. 42	FSUL WC596
NEW Combination Nightlight/GFCI								
1595-NTLICCC4	15	125	0.1618	Ivory	5-15R	•	•	•
1595-NTLWCC4	15	125	0.1618	White	5-15R	•	•	•
1595-NTLBKCC4	15	125	0.1618	Black	5-15R	•	•	•
1595-NTLLACC4	15	125	0.1618	Light Almond	5-15R	•	•	•
2095-NTLI	20	125	0.1233	Ivory	5-20R	•	•	•
2095-NTLW	20	125	0.1233	White	5-20R	•	•	•
2095-NTLGRY	20	125	0.1233	Gray	5-20R	•	•	•
2095-NTLRED	20	125	0.1233	Red	5-20R	•	•	•
2095-NTLLA	20	125	0.1233	Light Almond	5-20R	•	•	•
NEW Hospital Grade Combination Nightlight/GFCI								
1595-HGNTLI	15	125	0.1618	Ivory	5-15R	•	•	•
1595-HGNTLW	15	125	0.1618	White	5-15R	•	•	•
1595-HGNTL	15	125	0.1618	Brown	5-15R	•	•	•
1595-HGNTLGRY	15	125	0.1618	Gray	5-15R	•	•	•
1595-HGNTLRED	15	125	0.1618	Red	5-15R	•	•	•
1595-HGNTLLA	15	125	0.1618	Light Almond	5-15R	•	•	•
2095-HGNTLI	20	125	0.1233	Ivory	5-20R	•	•	•
2095-HGNTLW	20	125	0.1233	White	5-20R	•	•	•
2095-HGNTL	20	125	0.1233	Brown	5-20R	•	•	•
2095-HGNTLGRY	20	125	0.1233	Gray	5-20R	•	•	•
2095-HGNTLRED	20	125	0.1233	Red	5-20R	•	•	•
2095-HGNTLLA	20	125	0.1233	Light Almond	5-20R	•	•	•

*FCD = Foot Candle Distance, 1 Lumen = 1 FCD. See Page U-42 for more information.

Available Spring 2006.

All devices listed on this page conform to NEMA WD-1 and WD-6.

Pass & Seymour



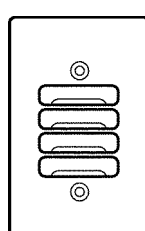

Wall Plates & Specialties

Incandescent Lampholders, Neon Pilot Lights & Panelites

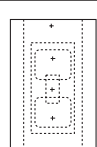
Description	Catalog Number
Incandescent Lampholders	
 <p>Designed to give adequate light when installed behind a louver plate or indicator jewel. Mounts in standard wall box. Plate mounting is 2-3/8" and 3-13/16". UL listed for 120 VAC circuits. Plate not included.</p> <p>Standard lampholder, 4 Watt 2152</p> <p>Extra long life: Integral series resistor in base reduces light output by about 40%, but increases lamp life more than ten times. Plate not included.</p> <p>Extra long life, 4 Watt 2156</p>	
 <p>Application</p> <p>Lampholders and louver plates are an ideal combination for providing bright, shielded light in hallways and pathways. They increase safety in corridors, theater aisles, porches, stairways, etc. A wide choice of plates gives unlimited possibilities for designing the perfect night light installation. Available in brushed brass, custom-painted stainless steel and stainless steel.</p> <p>For the complete listing of Louver Plates, see Page S-19.</p>	

Description	Catalog Number
Energy Efficient Gasket	
 <p>Gangable gasket, use for toggle, duplex, GFCI or blank. GASKET1</p>	

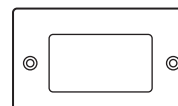

Description	Catalog Number
Neon Pilot Lights	
 <p>Long life neon bulb emits indicating light through transparent lens to show power is on. May be installed at the load, at switching posts or at remote locations. We suggest the wall plate be engraved to explain indication. Fits standard wall box and takes standard toggle switch plate opening. Plate mounting is 2-3/8". UL listed 120/277 VAC.</p> <p>With green lens 2151-GN</p> <p>With red lens 2151-RED</p> <p>With white lens 2151-W</p>	
Panelites	
<p>Panelites are attractive wall plates that light the message "IN USE" to protect darkrooms, private meeting areas, etc. Also available with a clear face for user to apply his own message. Furnished complete ready to wire. Panelites may be installed in a feed-through wall box, with the Panelite on one wall and a pilot light on the other. Panelite also may be installed in a standard wall box with the control switch in any desired location. With 4 Watt Incandescent bulb. Ivory plate.</p>	
 <p>2219-PL</p>	 <p>2220-PL</p>
 <p>2200-PL</p>	<p>INUSE, for Horizontal mounting . . 2219-PL</p> <p>IN USE, for Vertical mounting . . . 2220-PL</p> <p>With clear unprinted face 2200-PL</p>

UL Listed and CSA Certified.

Specialties Screws & Screwdrivers

Pass & Seymour

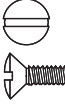
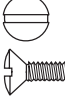
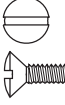

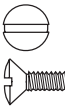
Description	Color or Finish	Catalog Number
Standard & Interchangeable Wall Plate Screws		
Oval Head Milled Slot 5/16" long, 6 x 32 Thread  Standard size for Decorator Wall Plates.	Ivory White Brown Gray Light Almond Stainless	509-I 509-W 509 509-GRY 509-LA 509-S
Oval Head Milled Slot 1/2" long, 6 x 32 Thread  Standard size for Duplex Receptacles and Toggle Switch Wall Plates.	Ivory White Brown Nickel Brass Stainless	510-I 510-W 510 510-N 510-BR 510-S
Oval Head Milled Slot 3/4" long, 6 x 32 Thread  Standard size for Blank Box Mounted Wall Plates.	Ivory White Brown Light Almond Stainless	511-I 511-W 511 511-LA 511-S
Oval Head Milled Slot 1" long, 6 x 32 Thread  Standard size for Blank Box Mounted Wall Plates.	Ivory White Brown Light Almond Stainless	512-I 512-W 512 512-LA 512-S
Oval Head Milled Slot 1-1/2" long, 6 x 32 Thread  Standard size for Blank Box Mounted Wall Plates.	Ivory White Brown Light Almond Stainless	513-I 513-W 513 513-LA 513-S

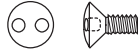
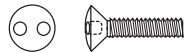
Description	Finish	Catalog Number
Tamper-Proof Spanner Head Screws		
Spanner Oval Head 1/2" long, 6 x 32 Thread 	430S/S	531-S
Spanner Oval Head 1" long, 6 x 32 Thread 	430S/S	532-S

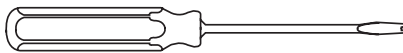
Description	Catalog Number
Screwdriver for Spanner Head or Key Slot Screws	
Screwdriver for Spanner Head Screw 	533-D

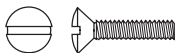
Description	Finish	Catalog Number
Nylon Screws for Standard and Interchangeable Wall Plates		
Oval Head Standard Slot 1/2" long, 6 x 32 Thread 	Ivory	528-I

Notes:

- Specify screws by catalog number to designate type of screw, thread, length, color or finish required.
- Screws are available by the box only.
- Order by number of boxes...not by the quantity of screws.
- Each box contains 100 screws.
- Metal screws are available with special finishes and can be painted.

Wall Plates Engraved & Pad Printed

Engraved (1/8" Characters)					
	Description	Plate Color	Fill Color	Nylon TradeMaster®	Metal Smooth
Emergency					
	1 Gang Duplex	302 S/S	Black		SS8-EE
	1 Gang Duplex	302 S/S Painted Red	Black		SS8-ERED

Pad Printed (1/8" Characters)					
	Description	Plate Color	Fill Color	Nylon TradeMaster®	Metal Smooth
Isolated Ground					
	1 Gang Duplex	Orange	Black	TP8-IG	SS8-IG
	1 Gang Duplex	302 S/S	Black		
	2 Gang Duplex	302 S/S	Black		SS82-IG
	1 Gang Single	Orange	Black	TP7-IG	SS7-IG
	1 Gang Single	302 S/S	Black		
	1 Gang Decorator	Orange	Black	TP26-IG	SS26-IG
	1 Gang Decorator	302 S/S	Black		

Emergency					
	1 Gang Duplex	Ivory	Red	TP8-EI TP8-EW TP8-ERED	SS8-ES
	1 Gang Duplex	White	Red		
	1 Gang Duplex	Red	Black		
	1 Gang Duplex	302S/S	Black		
	2 Gang Duplex	Red	Black	TP82-ERED	
	1 Gang Toggle	Red	Black	TP1-ERED	
	2 Gang Toggle	Red	Black	TP2-ERED	

Wall Plates Engraved & Pad Printed

Pass & Seymour

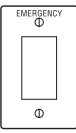
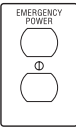
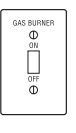
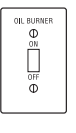
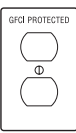
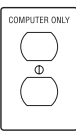
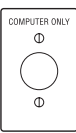
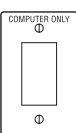

Pad Printed (1/8" Characters)					
	Description	Plate Color	Fill Color	Nylon TradeMaster®	Metal Smooth
Emergency					
	1 Gang Decorator	Red	Black	TP26-ERED	
	1 Gang Duplex	Red	Black	TP8-EMPOWER	
Gas Burner ON/OFF Emergency Switch					
	1 Gang Toggle	302 S/S Painted Red	Black		SS1-GBRED
Oil Burner ON/OFF Emergency Switch					
	1 Gang Toggle	302 S/S Painted Red	Black		SS1-OBRED
GFCI Protected					
	1 Gang Duplex	Ivory	Black	TP8-GFI	
	1 Gang Duplex	White	Black	TP8-GFW	
Computer Only					
	1 Gang Duplex	Ivory	Black	TP8-CI	
	1 Gang Duplex	Orange	Black	TP8-CO	
	Single Receptacle	Ivory	Black	TP7-CI	
	Single Receptacle	Orange	Black	TP7-CO	
	1 Gang Decorator	Ivory	Black	TP26-CI	
	1 Gang Decorator	Blue	Black	TP26-CBL	
	1 Gang Decorator	Orange	Black	TP26-CO	



Wall Plates

Custom Metal Wall Plates

Ordering Instructions

Ordering Instructions:

1. Using the following charts, fill in the spaces provided to select the proper material, number of gangs, desired finish and color.

Review Your Requirements:	For Example:	Write Your Selection:	Space #
Material Prefix Code (Chart A below) <i>For Jr. Jumbo Size add "J" after prefix, if Jumbo Size, add "O" after Prefix</i>	SBO		1
Total Number of Gangs Ordered	4		2
Paint Finish Suffix (Chart B – Page S-41)	BLU		4
Metal Finish Suffix (Chart C – Page S-41)	BC		5

Material	Prefix Code
Chart A: Material Selection	
Aluminum*	SA
Brushed Brass	SB
302 Stainless Steel	SS

*Standard size only.

2. Review the Plate Opening Styles on pages S-45 – S-57. Following the sequence of your installation (left to right), label each box below with the appropriate Opening Style Number for each gang.

Gang:	1	2	3	4	5	6	7	8	9	10

3. Create the Complete Order Part Number by filling in items from previous steps in spaces below.

Space #1-Material Prefix Code (from step 1) Space #4-Metal Finish Suffix (from step 1)
 Space #2-Total Number of Gangs (from step 1) Space #5-Paint Finish Suffix (from step 1)
 Space #3-Style Numbers In Order (from step 2)

Catalog # _____ G _____ Style _____ - _____ - _____ - _____ - _____ - _____ - _____ - _____ - _____ - _____ - _____ - _____ - _____ - _____ - _____ - _____
 Space # 1 2 3 3 3 3 3 3 3 3 3 3 4 5

Maximum Gangs for Custom Metal Wall Plates			
Metal Plate	Standard	Jr. Jumbo	Jumbo
Stainless (302)	20	3	20
Aluminum	8	N/A	N/A
Brushed Brass	8	3	20

For help with configuring a Custom Metal Wall Plate, go to www.passandseymour.com and select Downloads/Product Selection Guides/Custom Wall Plates.

Wall Plates

Custom Metal Wall Plates

Special Configurations

Pass & Seymour



Chart B: Paint Finish Selection							
Paint Color	Light Blue	Orange	Navy	Peach	Hunter Green	Gray	Yellow
Paint Suffix	BLU	ORG	NAV	PCH	HGR	GRY	YEL
Paint Color	Glossy Black	Brown	Burgundy	White	Primer	Red	
Paint Suffix	GBK	CHO	BRG	WHT	PRI	RED	
Paint Color	Beige	Pink	Flat Black	Ivory	Light Almond	Medium Blue	
Paint Suffix	BGE	PNK	FBK	IVY	LTA	MBL	

Only available on Stainless Steel and Aluminum Plate Material. Colors may vary slightly.
All Paint Finishes are gloss, except primer and flat black.

Chart C: Metal Finish Selection					
Metal Finish	Polished Brass US #3	Bright Chromium US #26	Brushed Copper	Brushed Bronze US #10	Brushed Brass Standard Finish
Finish Suffix	PB*	CH	BC	BZ	BB

*Order with Brass Plate Material Prefix Only.

Wall Plates

Custom Metal Wall Plates

Engraving & Pad Printing

Custom Engraving & Pad Printing

Most plates in this catalog can be engraved or pad printed. However, engraving plated finish metal plates is not recommended, since exposed edges could oxidize over time. Refer to current price sheet to select the better process that suits your needs.

Position

Marking may appear anywhere on the flat surface of smooth plates.
 On Decorator plates, markings are restricted to the top and bottom flat panels.
 If space permits, up to three lines can be pad printed on a plate provided the lettering fits within a 50mm circle.

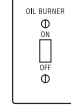
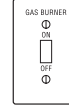

Letter Height

Unless specified otherwise, designers will select size and position of letters or markings for maximum legibility. Characters per inch:

3/8" - 2-1/2 1/4" - 4 3/16" - 6 1/8" - 9 1/16" - 14



Letter Font

Pad printing is available in any True Type font in colors listed below, on 1 gang and 2 gang plates. Bitmap images can also be printed.
 Laser engraving is available in any True Type font only in black (not color-filled) including bitmap images.
 Engraving with color fill is available only in block letter font. While mixing of laser and color-filled engraving is allowed, it is not recommended since the font types will not match.

Color

Color-filled engraving can be filled with red, orange, black, blue, or white paint.
 Standard colors for pad printing are red, black, blue, green, orange or white, as shown below.

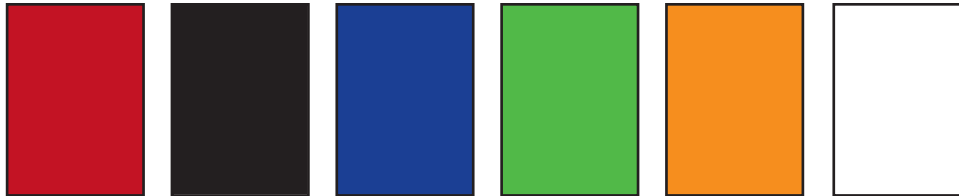

Red Black Blue Green Orange White

Ordering Instructions

Specify clearly the following information when you order.

1. Catalog number of plate(s).
2. To be engraved or pad printed.
3. Letters, numbers, characters required.
4. Position and size.
5. Color of filler, or pad printing.
6. Special layout information, if applicable.

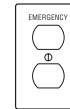

Position
 Height of Mark
 Color of Filler

Plate Style
 by Catalog Number
 Including
 Color/Finish

Wall Plates Custom Panel Plates

Ordering Instructions

Pass & Seymour



Blank panel plates (PP-series) up to 5-gangs high and 10-gangs wide are made from Type 302 Stainless Steel. Up to 50 openings from the style selector guide can be custom punched to your specifications. For uniformity of design throughout the building, panel plates have the same distinctive styling as all other plates, plastic and metal.

Ordering Instructions

For this example, use the 4 gang high by 2 gang wide panel plate illustrated in Figure 2.

1. Start the catalog number with the material prefix: "SS" for Type 302 Stainless. This is a 302 Stainless plate, so the first letters of its catalog number will be "SS".
2. Determine the catalog number for a panel plate 4 gangs high and 2 gangs wide from the table on page S-44. It is PP-4-2. Your 302 Stainless Steel catalog number is SSPP-4-2.
3. Construct a chart upon which you can indicate the opening style number for each of the 8 gangs, starting from the top left. Leave space to show any words or symbols that will be engraved. Write the catalog number SSPP-4-2 at the top of the chart. See Figure 1.
4. Refer to the Style Selector Guide and find the style numbers for each of the desired openings. Write these numbers in their appropriate position on your chart.
5. Indicate what, if any, engraving is required for each gang. Show in parentheses if engraving is to be above or below the opening.
6. Send the chart with your order to the factory. You have provided all required information. Refer to current price sheet for pricing details.

Additional Information

- Where no opening or mounting holes are required, specify Style #149.
- Louvered openings can be placed only on the top row of a panel plate.
- For painted or special metal finishes, refer to price sheet for price adds per gang.
- For special openings not in Selector Guide, provide detailed drawing.

Example		
SSPP-4-2		
ROW #1:		
Style Nos.	1	1
Engraving:	ALTAR	CHOIR
	(Above)	(Above)
ROW #2:		
Style Nos.	9	9
Engraving:	(None)	(None)
ROW #3:		
Style Nos.	12	12
Engraving:	(None)	TEL
		(Above)
ROW #4:		
Style Nos.	16	16
Engraving:	(None)	120V.
		(Above)

Figure 1

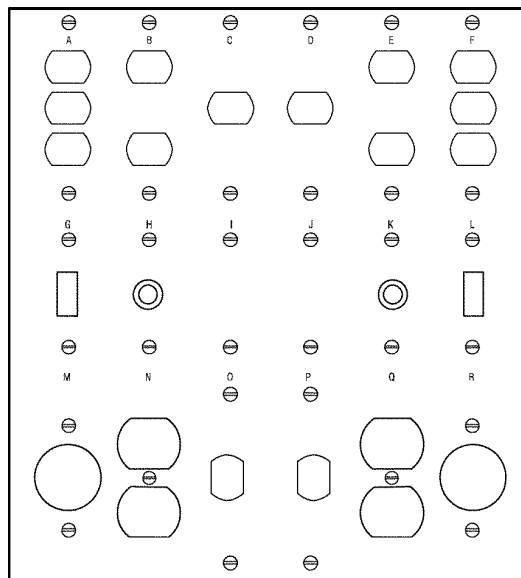

Custom Panel Plate

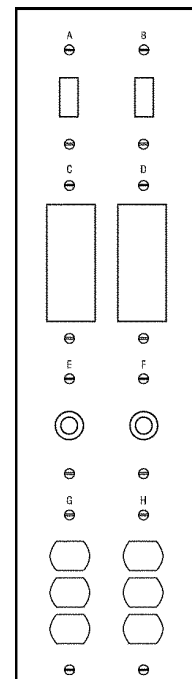

Figure 2

Wall Plates Custom Panel Plates

Ordering Instructions

Wall Box Dimensions

Panel Plates are limited to fit the box configuration shown.

Caution: Not all boxes are identical in overall dimensions, but are built to exact standards on device mounting holes. When boxes are connected together, they should be shimmed to ensure that the bottom hole to bottom hole dimension between two vertically adjacent boxes is 4-1/8" as errors are cumulative. Critical dimensions circled.

If additional mounting holes are required in the corners, indicate location and spacing.

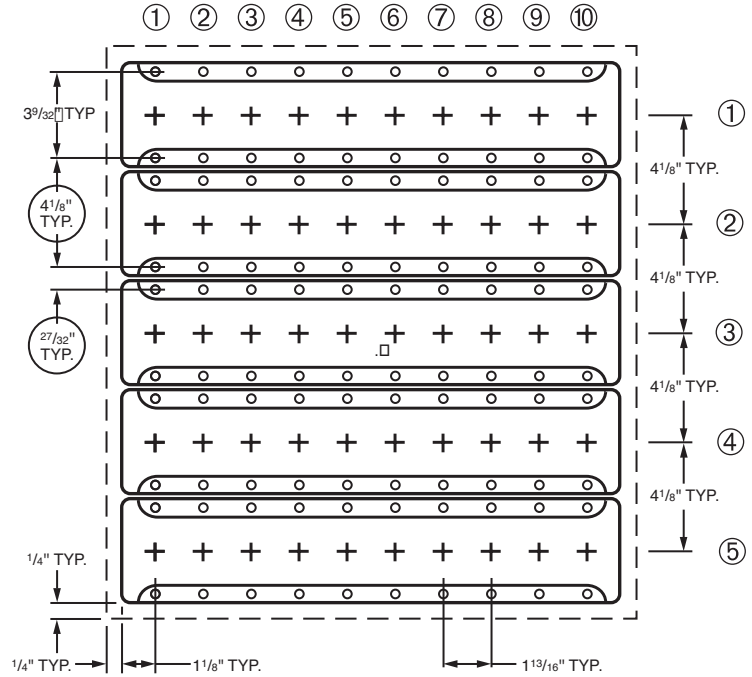

302 Stainless Steel

Plate Height	Catalog Number	Gangs Wide	Plate Width
Two Gangs High 8-3/4"	PP-2-1	One	2-3/4"
	PP-2-2	Two	4-9/16"
	PP-2-3	Three	6-3/8"
	PP-2-4	Four	8-3/16"
	PP-2-5	Five	10"
	PP-2-6	Six	11-13/16"
	PP-2-7	Seven	13-5/8"
	PP-2-8	Eight	15-7/16"
	PP-2-9	Nine	17-1/4"
	PP-2-10	Ten	19-1/16"
Three Gangs High 12-7/8"	PP-3-1	One	2-3/4"
	PP-3-2	Two	4-9/16"
	PP-3-3	Three	6-3/8"
	PP-3-4	Four	8-3/16"
	PP-3-5	Five	10"
	PP-3-6	Six	11-13/16"
	PP-3-7	Seven	13-5/8"
	PP-3-8	Eight	15-7/16"
	PP-3-9	Nine	17-1/4"
	PP-3-10	Ten	19-1/16"

Plate Height	Catalog Number	Gangs Wide	Plate Width
Four Gangs High 17"	PP-4-1	One	2-3/4"
	PP-4-2	Two	4-9/16"
	PP-4-3	Three	6-3/8"
	PP-4-4	Four	8-3/16"
	PP-4-5	Five	10"
	PP-4-6	Six	11-13/16"
	PP-4-7	Seven	13-5/8"
	PP-4-8	Eight	15-7/16"
	PP-4-9	Nine	17-1/4"
	PP-4-10	Ten	19-1/16"
Five Gangs High 21-1/8"	PP-5-1	One	2-3/4"
	PP-5-2	Two	4-9/16"
	PP-5-3	Three	6-3/8"
	PP-5-4	Four	8-3/16"
	PP-5-5	Five	10"
	PP-5-6	Six	11-13/16"
	PP-5-7	Seven	13-5/8"
	PP-5-8	Eight	15-7/16"
	PP-5-9	Nine	17-1/4"
	PP-5-10	Ten	19-1/16"

Wall Plates Style Selector Guide

Custom Metal Wall Plates

Pass & Seymour



<p>STYLE 1</p> <p>TOGGLE SWITCH #1 Standard Plate page S-6</p>	<p>STYLE 2</p> <p>TOGGLE SWITCH #1 Standard Plate page S-6</p>	<p>STYLE 3</p> <p>TOGGLE SWITCH #1 Standard Plate page S-6</p>	<p>STYLE 4</p> <p>TOGGLE SWITCH #1 Standard Plate page S-6</p>
<p>STYLE 5</p> <p>TOGGLE SWITCH #1 Standard Plate page S-6</p>	<p>STYLE 7</p> <p>SINGLE OUTLET #7 Standard Plate page S-11</p>	<p>STYLE 8</p> <p>DUPLEX OUTLET #8 Standard Plate page S-7</p>	<p>STYLE 9</p> <p>BIPLEX/TRIPLEX #9 Standard Plate page S-19</p>
<p>STYLE 10</p> <p>PUSH BUTTON #10 Standard Plate page S-10</p>	<p>STYLE 11</p> <p>TELEPHONE, BOX MTD. #11 Standard Plate page S-30</p>	<p>STYLE 12</p> <p>TELEPHONE, STRAP MTD. with #340 Yoke #12 Standard Plate page S-30</p>	<p>STYLE 13</p> <p>BLANK, BOX MTD. #13 Standard Plate page S-9</p>
<p>STYLE 14</p> <p>BLANK, STRAP MTD. with #340 Yoke #14 Standard Plate page S-10</p>	<p>STYLE 16</p> <p>SINGLE OUTLET FOR 1600 SERIES #16 Standard Plate page S-10</p>	<p>STYLE 17</p> <p>SINGLE RECEPTACLE FOR 1600 SERIES CENTERED 2 GANG #17 Standard Plate page S-10</p>	<p>STYLE 18</p> <p>TOGGLE SWITCH CENTERED 2 GANG #18 Standard Plate page S-18</p>

All wall plate dimensions shown above are in inches.

Wall Plates Style Selector Guide

Custom Metal Wall Plates

<p>STYLE 19</p> <p>SINGLE OUTLET CENTERED 2 GANG #747 Standard Plate page S-18</p>	<p>STYLE 20</p> <p>DUPLEX OUTLET CENTERED 2 GANG #748 Standard Plate page S-18</p>	<p>STYLE 21</p> <p>BIPLEX/TRIPLEX CENTERED 2 GANG</p>	<p>STYLE 22</p> <p>DECORATOR/GFCI CENTERED 2 GANG #746 Standard Plate page S-18</p>
<p>STYLE 23</p> <p>BLANK, BOX MTD. #23 Standard Plate page S-9</p>	<p>STYLE 24</p> <p>BLANK, STRAP MTD. with 2 #340 Yokes #24 Standard Plate page S-10</p>	<p>STYLE 25</p> <p>TELEPHONE JACK OUTLET NOTE: Special Plate Mounting</p>	<p>STYLE 26</p> <p>DECORATOR/GFCI #26 Standard Plate page S-7</p>
<p>STYLE 27</p> <p>ONE DESPARD® INTERCHANGEABLE with #348 Strap Standard Plate page S-17 STYLE 27A — BOX MTD.</p>	<p>STYLE 28</p> <p>TWO DESPARD® INTERCHANGEABLE with #348 Straps Standard Plate page S-17 STYLE 29 — BOX MTD.</p>	<p>STYLE 30</p> <p>THREE DESPARD® INTERCHANGEABLE with #348 Straps Standard Plate page S-17 STYLE 31 — BOX MTD.</p>	<p>STYLE 32</p> <p>ONE VERTICAL DESPARD® INTERCHANGEABLE with #347 Strap Standard Plate page S-17</p>
<p>STYLE 33</p> <p>STYLE 33</p>	<p>STYLE 36</p> <p>STYLE 36</p>	<p>STYLE 37</p> <p>STYLE 37</p>	<p>STYLE 38</p> <p>STYLE 38</p>

All wall plate dimensions shown above are in inches.

Wall Plates Style Selector Guide

Custom Metal Wall Plates

Pass & Seymour



Wall Plates & Specialties

<p>STYLE 40</p>	<p>STYLE 41</p>	<p>STYLE 42</p>	<p>STYLE 43</p>
<p>STYLE 44</p>	<p>STYLE 45</p>	<p>STYLE 46</p>	<p>STYLE 47</p>
<p>STYLE 48</p> <p>NOTE: Engraving Extra at Standard Price per Character</p>	<p>STYLE 49</p> <p>STYLE 49A – Vertical Opening STYLE 50 – 2 Openings 1 Gang STYLE 51 – 3 Openings 1 Gang STYLE 52 – 4 Openings 1 Gang</p>	<p>STYLE 55</p> <p>with #340 Yoke STYLE 56 – BOX MTD.</p>	<p>STYLE 57</p> <p>with #340 Yoke STYLE 58 – BOX MTD.</p>
<p>STYLE 59</p> <p>#with #340 Yoke STYLE 60 – BOX MTD. STYLE 61 – DESP. INTCH. MTD.</p>	<p>STYLE 62</p> <p>STYLE 63 – BOX MTD.</p>	<p>STYLE 64</p> <p>STYLE 65 – BOX MTD.</p>	<p>STYLE 66</p> <p>STYLE 67 – BOX MTD.</p>

All wall plate dimensions shown above are in inches.

Style Selector Guide

Wall Plates Style Selector Guide

Custom Metal Wall Plates

<p>STYLE 68</p> <p>STYLE 69 — BOX MTD. STYLE 70 — DESP. INTCH. MTD.</p>	<p>STYLE 71</p> <p>STYLE 72 — BOX MTD.</p>	<p>STYLE 73</p> <p>STYLE 74 — BOX MTD.</p>	<p>STYLE 75</p> <p>Clearance for 1 1/8" Device STYLE 76 — BOX MTD.</p>
<p>STYLE 77</p> <p>STYLE 78 — BOX MTD. STYLE 79 — DESP. INTCH. MTD.</p>	<p>STYLE 80</p> <p>STYLE 81 — BOX MTD. STYLE 82 — DESP. INTCH. MTD.</p>	<p>STYLE 83</p> <p>STYLE 84 — BOX MTD. STYLE 85 — DESP. INTCH. MTD.</p>	<p>STYLE 86</p> <p>STYLE 87 — BOX MTD. STYLE 88 — DESP. INTCH. MTD.</p>
<p>STYLE 89</p> <p>STYLE 90 — BOX MTD.</p>	<p>STYLE 91</p> <p>POWER OUTLET #720 Standard Plate page S-11</p>	<p>STYLE 92</p> <p>STYLE 93 — DESP. INTCH. MTD.</p>	<p>STYLE 94</p> <p>STYLE 95 — BOX MTD. STYLE 96 — DESP. INTCH. MTD.</p>
<p>STYLE 97</p>	<p>STYLE 98</p> <p>POWER OUTLET #723 Standard Plate page S-11</p>	<p>STYLE 99</p>	<p>STYLE 100</p> <p>with 2 # 340 Yokes STYLE 101 — BOX MTD.</p>

All wall plate dimensions shown above are in inches.

Wall Plates Style Selector Guide

Custom Metal Wall Plates

Pass & Seymour



<p>STYLE 102</p> <p>STYLE 103 — BOX MTD.</p>	<p>STYLE 104</p> <p>STYLE 105 — BOX MTD.</p>	<p>STYLE 106</p> <p>STYLE 107 — BOX MTD.</p>	<p>STYLE 110</p> <p>STYLE 111 — BOX MTD.</p>
<p>STYLE 112</p> <p>STYLE 113 — BOX MTD. STYLE 114 — DESP. INTCH. MTD.</p>	<p>STYLE 115</p> <p>STYLE 116</p> <p>STYLE 117 — BOX MTD. STYLE 118 — DESP. INTCH. MTD.</p>	<p>STYLE 119</p> <p>STYLE 120 — BOX MTD.</p>	
<p>STYLE 121</p> <p>STYLE 122</p> <p>STYLE 123</p> <p>STYLE 124</p> <p>STYLE 125 — 2 HOLES STYLE 126 — 3 HOLES</p>			
<p>STYLE 131</p> <p>STYLE 132</p> <p>STYLE 133</p> <p>POWER OUTLET #701 Standard Plate page S-12</p>	<p>STYLE 134</p> <p>STYLE 135</p> <p>STYLE 135A — DESP. INTCH. MTD. #771 Standard Plate page S-19</p>		

All wall plate dimensions shown above are in inches.

Wall Plates
Style Selector Guide

Custom Metal Wall Plates

<p>STYLE 136</p> <p>RAZOR BLADES with #340 Yoke</p>	<p>STYLE 137</p> <p>RAZOR BLADES, BOX MTD. STYLE 137B — HORIZONTAL RAZOR BLADE, BOX MTD.</p>	<p>STYLE 138</p> <p>STYLE 139 — BOX MTD. STYLE 140 — DESP. INTCH. MTD.</p>	<p>STYLE 141</p>
<p>STYLE 142</p>	<p>STYLE 143</p>	<p>STYLE 144</p> <p>STYLE 145 — 3 OPENINGS STYLE 146 — 4 OPENINGS STYLE 147 — MASTER CONTROL</p>	<p>STYLE 149</p>
<p>STYLE 150</p> <p>DESP. INTCH. MTD.</p>	<p>STYLE 152</p> <p>TELEPHONE OUTLET CENTERED 2 GANG, with #340 Yoke STYLE 151 — BOX MTD. #741, 742 Standard Plate page S-32</p>	<p>STYLE 155</p> <p>POWER OUTLET #702 Standard Plate page S-12</p>	<p>STYLE 156</p> <p>POWER OUTLET #703 Standard Plate page S-12</p>
<p>STYLE 160</p>	<p>STYLE 162</p> <p>STYLE 176 — STRAP MTD. with #340 Yoke #743 Standard Plate page S-18</p>	<p>STYLE 163</p> <p>POWER OUTLET #721 Standard Plate page S-11</p>	<p>STYLE 165</p> <p>POWER OUTLET #724 Standard Plate page S-11</p>

All wall plate dimensions shown above are in inches.

Wall Plates Style Selector Guide

Custom Metal Wall Plates

Pass & Seymour



<p>STYLE 166</p> <p>C'SK FOR 6-32x5/16 OVAL HD. SCREW 2 PLACES</p>	<p>STYLE 169</p> <p>C'SK FOR 6-32x1/2 OVAL HD. SCREW 2 PLACES</p>	<p>STYLE 171</p> <p>C'SK FOR 6-32x1/2 OVAL HD. SCREW 2 PLACES</p>	<p>STYLE 172</p> <p>C'SK FOR 6-32x1/2 OVAL HD. SCREW 4 PLACES</p>
<p>STYLE 177</p> <p>C'SK FOR 6-32x5/16 OVAL HD. SCREW 2 PLACES</p> <p>STYLE 178 Touch Plate 50-2, 2 Openings STYLE 179 Touch Plate 50-3, 3 Openings Box Mtd.</p>	<p>STYLE 180</p> <p>C'SK FOR 6-32x1/2 OVAL HD. SCREW 2 PLACES</p>	<p>STYLE 181</p> <p>C'SK FOR 6-32x1/2 OVAL HD. SCREW 4 PLACES</p>	<p>STYLE 182</p> <p>C'SK FOR 6-32x1/2 OVAL HD. SCREW 2 PLACES</p>
<p>STYLE 183</p> <p>C'SK FOR 6-32x1/2 OVAL HD. SCREW 1 PLACE</p>	<p>STYLE 185</p> <p>C'SK FOR 6-32x1/2 OVAL HD. SCREW 2 PLACES</p>	<p>STYLE 187</p> <p>C'SK FOR 6-32x1/2 OVAL HD. SCREW 2 PLACES</p>	<p>STYLE 188</p> <p>C'SK FOR 6-32x1/2 OVAL HD. SCREW 2 PLACES</p>
<p>STYLE 189</p> <p>C'SK FOR 6-32x1/2 OVAL HD. SCREW 2 PLACES</p> <p>STYLE 190 — BOX MTD.</p>	<p>STYLE 191</p> <p>C'SK FOR 6-32x1/2 OVAL HD. SCREW 2 PLACES</p> <p>STYLE 192 — BOX MTD. STYLE 193 — DESP. INTCH. MTD.</p>	<p>STYLE 194</p> <p>C'SK FOR 6-32x1/2 OVAL HD. SCREW 2 PLACES</p> <p>POWER OUTLET #725 Standard Plate page S-11 STYLE 195 — BOX MTD. STYLE 196 — DESP. INTCH. MTD.</p>	<p>STYLE 199</p> <p>C'SK FOR 6-32x1/2 OVAL HD. SCREW 2 PLACES</p>

All wall plate dimensions shown above are in inches.

Wall Plates Style Selector Guide

Custom Metal Wall Plates

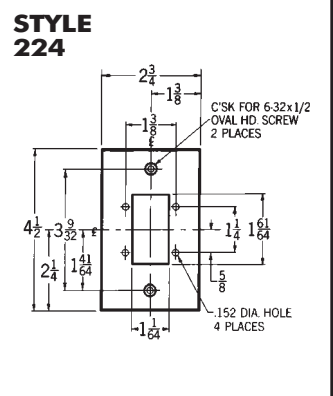
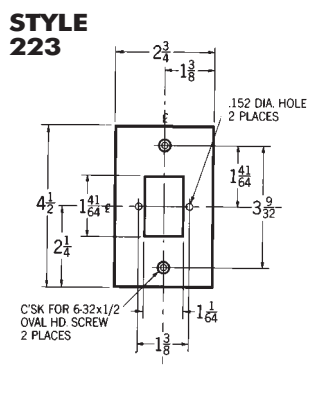
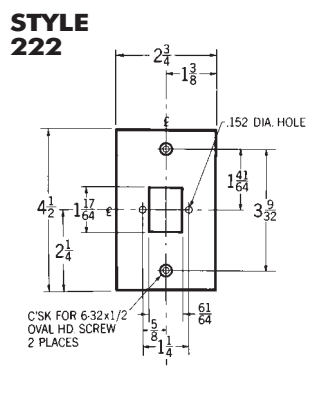
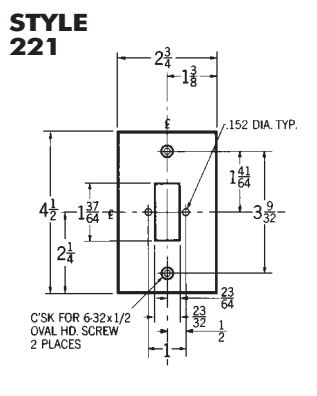
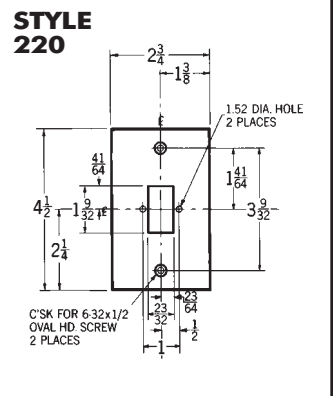
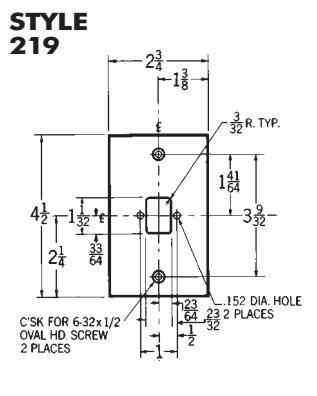
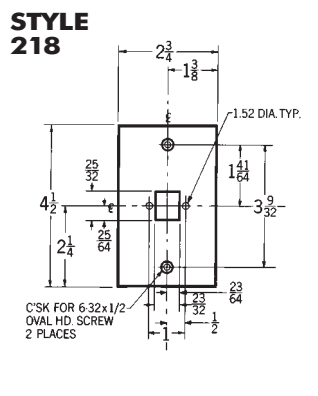
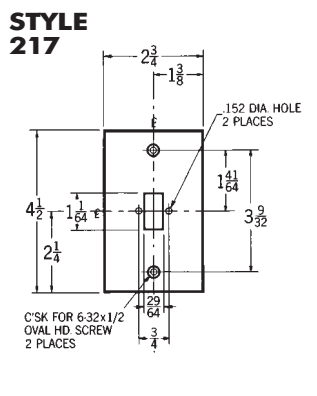
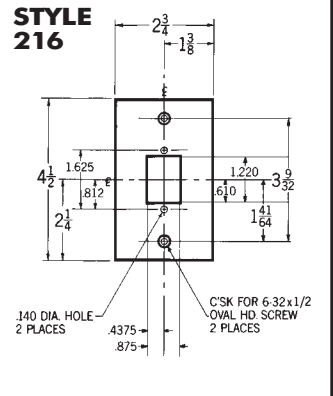
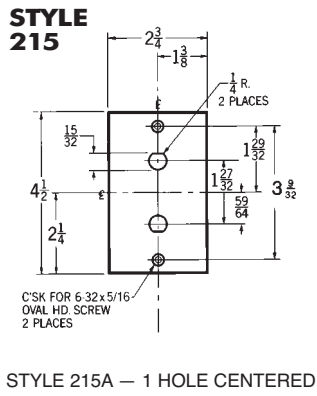
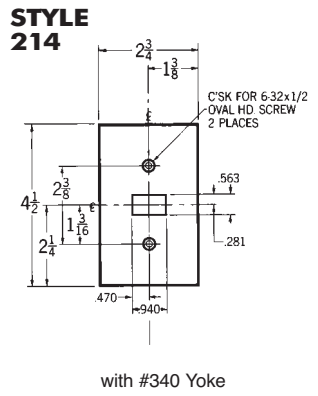
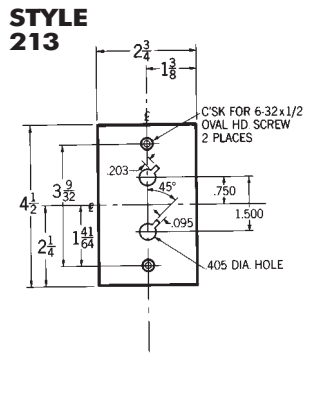
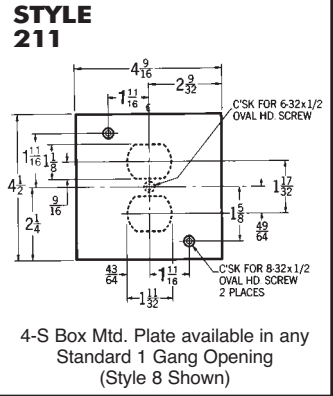
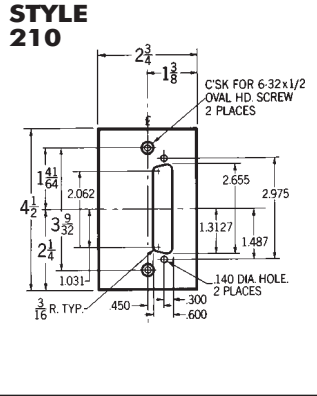
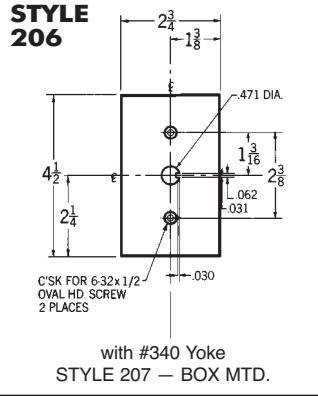
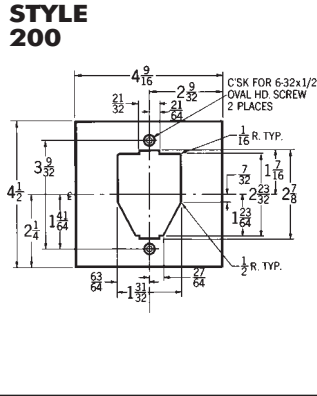

All wall plate dimensions shown above are in inches.

Wall Plates Style Selector Guide

Custom Metal Wall Plates

Pass & Seymour



<p>STYLE 225</p> <p>152 DIA. HOLE TYP. - 4 PLACES</p> <p>C'SK FOR 6-32x1/2 OVAL HD. SCREW 2 PLACES</p>	<p>STYLE 226</p> <p>152 DIA. HOLE 4 PLACES</p> <p>C'SK FOR 6-32x1/2 OVAL HD. SCREW 2 PLACES</p>	<p>STYLE 227</p> <p>4 1/4 DIA. HOLE</p> <p>C'SK FOR 6-32x1/2 OVAL HD. SCREW 2 PLACES</p>	<p>STYLE 228</p> <p>C'SK FOR 6-32x1/2 OVAL HD. SCREW 2 PLACES</p> <p>4 1/4 DIA. HOLE 2 PLACES</p>
<p>STYLE 229</p> <p>C'SK FOR 6-32x1/2 OVAL HD. SCREW 4 PLACES</p> <p>1 1/2 DIA. HOLE</p>	<p>STYLE 230</p> <p>C'SK FOR 6-32x1/2 OVAL HD. SCREW 2 PLACES</p> <p>140 DIA. HOLE 2 PLACES</p>	<p>STYLE 232</p> <p>1.555 DIA. HOLE</p> <p>C'SK FOR 6-32x1/2 OVAL HD. SCREW 2 PLACES</p> <p>5/8 DIA. HOLE 2 PLACES</p>	<p>STYLE 233</p> <p>1/8 DIA. TYP.</p> <p>1/2 DIA. 1 DIA.</p> <p>C'SK FOR 6-32x1/2 OVAL HD. SCREW 2 PLACES</p> <p>STYLE 233A — EXTRA CIRCLE OF HOLES (31 HOLES)</p>
<p>STYLE 235</p> <p>C'SK FOR 6-32x1/2 OVAL HD. SCREW 2 PLACES</p> <p>1 1/4 DIA. HOLE</p>	<p>STYLE 236</p> <p>C'SK FOR 6-32x1/2 OVAL HD. SCREW 2 PLACES</p>	<p>STYLE 237</p> <p>1 1/2 DIA. HOLE</p> <p>C'SK FOR 6-32x1/2 OVAL HD. SCREW 2 PLACES</p> <p>5 HOLES 1/8 DIA. 5/16 DIA.</p> <p>with #340 Yoke STYLE 238 — BOX MTD.</p>	<p>STYLE 239</p> <p>C'SK FOR 6-32x1/2 OVAL HD. SCREW 2 PLACES</p> <p>476 DIA</p>
<p>STYLE 240</p> <p>1 1/4 DIA. HOLE</p> <p>C'SK FOR 6-32x1/2 OVAL HD. SCREW 2 PLACES</p>	<p>STYLE 241</p> <p>C'SK FOR 6-32x1/2 OVAL HD. SCREW 2 PLACES</p> <p>140 DIA. HOLE</p>	<p>STYLE 242</p> <p>C'SK FOR 6-32x1/2 OVAL HD. SCREW 2 PLACES</p> <p>140 DIA. HOLE</p> <p>1 1/2 DIA. HOLE</p>	<p>STYLE 243</p> <p>C'SK FOR 6-32x1/2 OVAL HD. SCREW 2 PLACES</p> <p>1 1/4 DIA. HOLE</p>

All wall plate dimensions shown above are in inches.

Wall Plates
Style Selector Guide
 Custom Metal Wall Plates

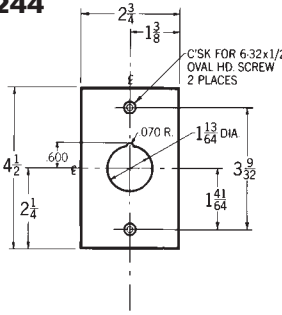
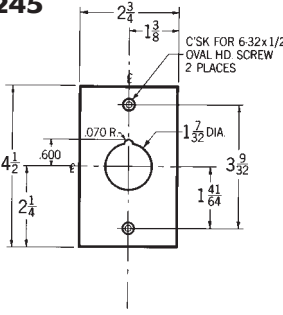
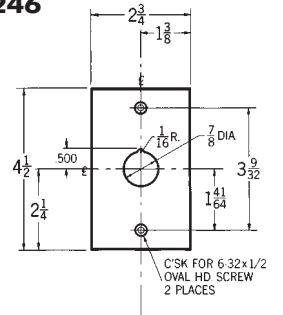
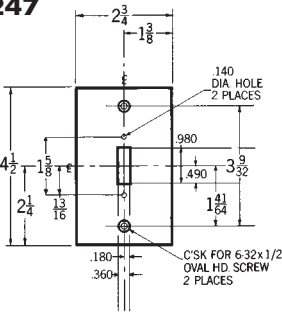
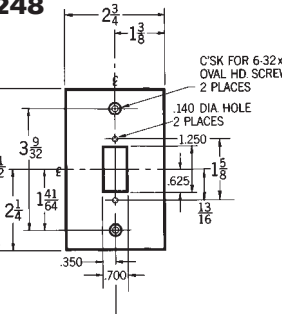
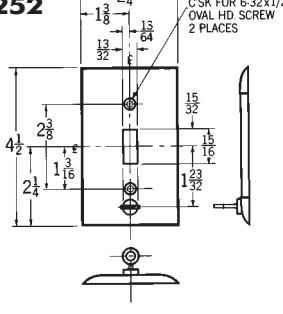
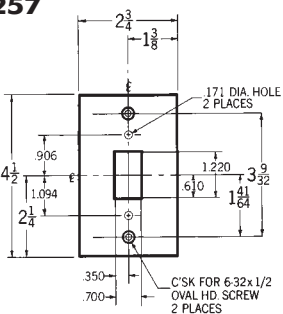
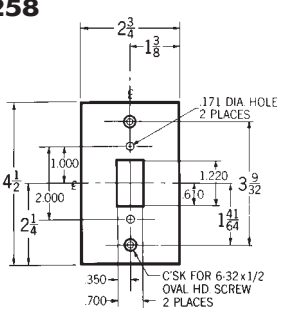
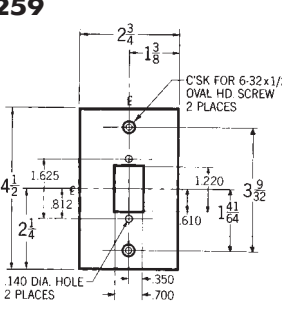
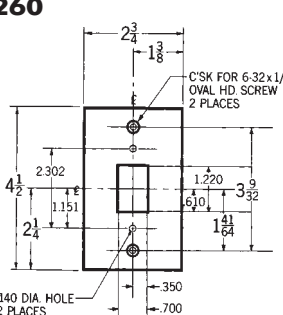
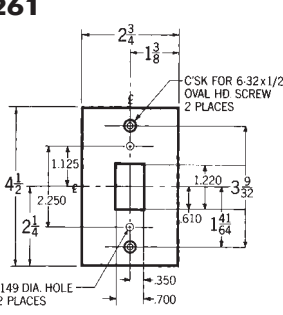
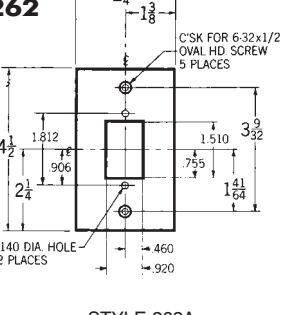
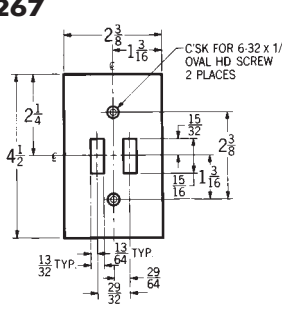
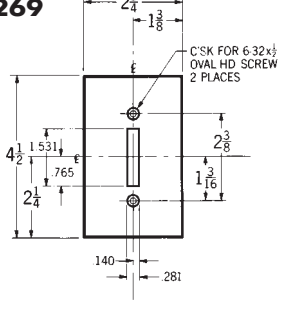
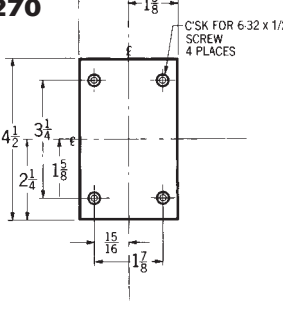
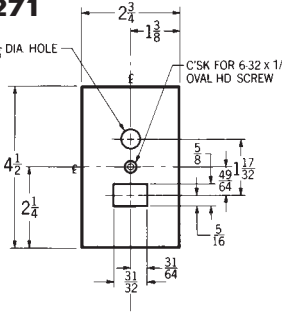
<p>STYLE 244</p>  <p>C'SK FOR 6-32x1/2 OVAL HD. SCREW 2 PLACES</p>	<p>STYLE 245</p>  <p>C'SK FOR 6-32x1/2 OVAL HD. SCREW 2 PLACES</p>	<p>STYLE 246</p>  <p>C'SK FOR 6-32x1/2 OVAL HD. SCREW 2 PLACES</p>	<p>STYLE 247</p>  <p>140 DIA HOLE 2 PLACES</p> <p>C'SK FOR 6-32x1/2 OVAL HD. SCREW 2 PLACES</p>
<p>STYLE 248</p>  <p>C'SK FOR 6-32x1/2 OVAL HD. SCREW 2 PLACES</p> <p>140 DIA HOLE 2 PLACES</p>	<p>STYLE 252</p>  <p>C'SK FOR 6-32x1/2 OVAL HD. SCREW 2 PLACES</p> <p>with Hospital Cord Eyelet</p>	<p>STYLE 257</p>  <p>171 DIA. HOLE 2 PLACES</p> <p>C'SK FOR 6-32x1/2 OVAL HD. SCREW 2 PLACES</p>	<p>STYLE 258</p>  <p>171 DIA. HOLE 2 PLACES</p> <p>C'SK FOR 6-32x1/2 OVAL HD. SCREW 2 PLACES</p>
<p>STYLE 259</p>  <p>C'SK FOR 6-32x1/2 OVAL HD. SCREW 2 PLACES</p> <p>140 DIA. HOLE 2 PLACES</p>	<p>STYLE 260</p>  <p>C'SK FOR 6-32x1/2 OVAL HD. SCREW 2 PLACES</p> <p>140 DIA. HOLE 2 PLACES</p>	<p>STYLE 261</p>  <p>C'SK FOR 6-32x1/2 OVAL HD. SCREW 2 PLACES</p> <p>149 DIA. HOLE 2 PLACES</p>	<p>STYLE 262</p>  <p>C'SK FOR 6-32x1/2 OVAL HD. SCREW 5 PLACES</p> <p>140 DIA. HOLE 2 PLACES</p> <p>STYLE 262A HORIZONTAL OPENING, BOX MTD.</p>
<p>STYLE 267</p>  <p>C'SK FOR 6-32 x 1/2 OVAL HD. SCREW 2 PLACES</p>	<p>STYLE 269</p>  <p>C'SK FOR 6-32x1/2 OVAL HD. SCREW 2 PLACES</p>	<p>STYLE 270</p>  <p>C'SK FOR 6-32 x 1/2 SCREW 4 PLACES</p> <p>F.S. BOX MTD.</p>	<p>STYLE 271</p>  <p>9/16 DIA HOLE</p> <p>C'SK FOR 6-32 x 1/2 OVAL HD. SCREW</p>

All wall plate dimensions shown above are in inches.

Wall Plates Style Selector Guide

Custom Metal Wall Plates

Pass & Seymour



Wall Plates & Specialties

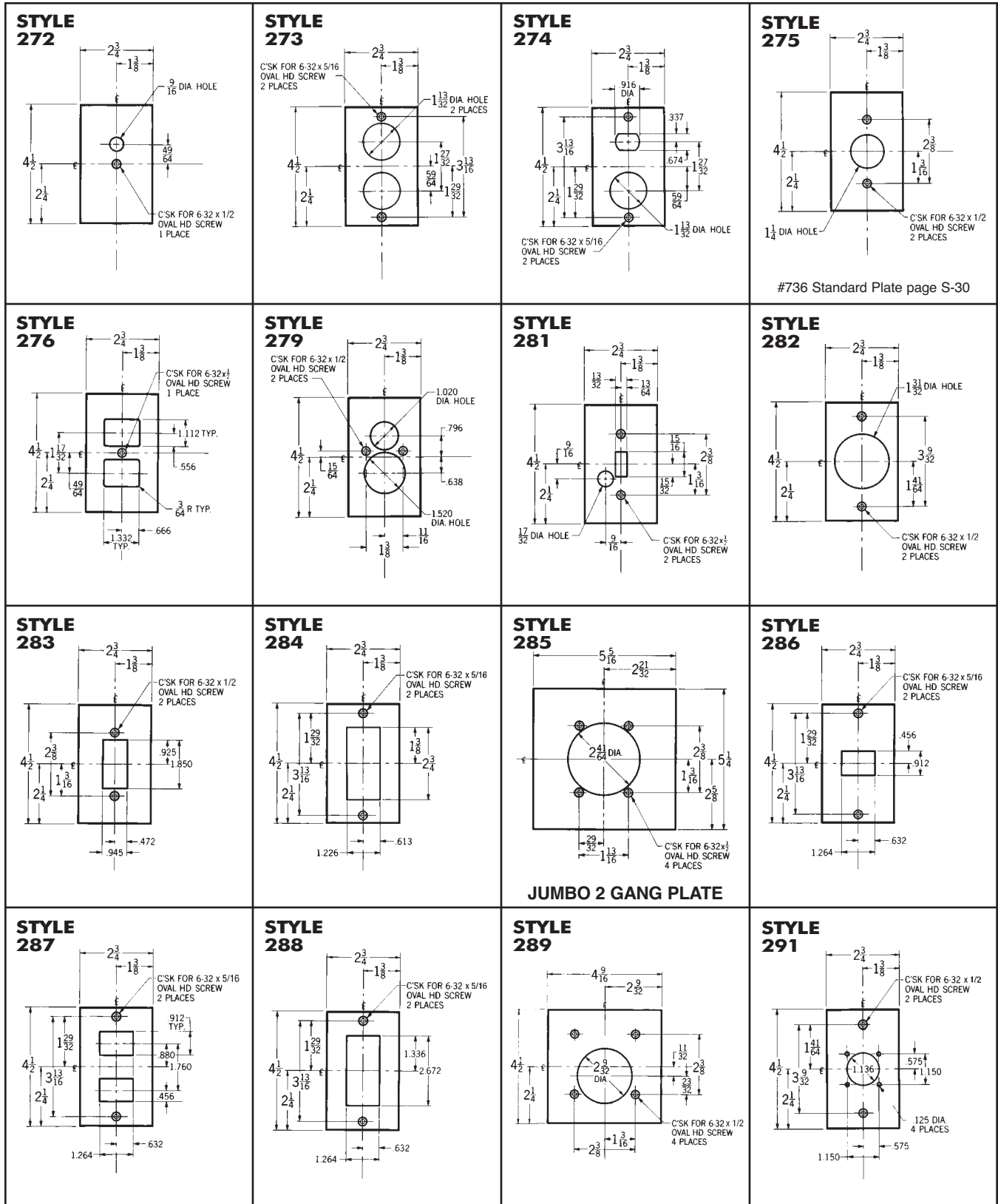

All wall plate dimensions shown above are in inches.

Style Selector Guide

Wall Plates Style Selector Guide

Custom Metal Wall Plates

Pass & Seymour



<p>STYLE 308</p> <p>TELEPHONE JACK</p>	<p>STYLE 309</p> <p>TELEPHONE JACK</p>	<p>STYLE 310</p> <p>AMP ELECTRONIC CONNECTOR</p>	<p>STYLE 311</p> <p>COAXIAL ELECTRONIC CONNECTOR</p>
<p>STYLE 312</p> <p>COAXIAL ELECTRONIC CONNECTOR</p>	<p>STYLE 313</p> <p>COAXIAL ELECTRONIC CONNECTOR</p>	<p>STYLE 314</p> <p>LAN PORT</p>	<p>STYLE 315</p> <p>COAXIAL ELECTRONIC CONNECTOR</p>
<p>STYLE 315A</p> <p>COAXIAL ELECTRONIC CONNECTOR</p>	<p>STYLE 315B</p> <p>COAXIAL ELECTRONIC CONNECTOR</p>		

All wall plate dimensions shown above are in inches.