

Weatherproof Boxes & Covers

Pass & Seymour



Two sizes: 1.96" and 2.32" diameters to cover 15A/20A Straight Blade and 15A/20A/30A Turnlok® devices. Covers fit all competitive flanged inlets and outlets.

Tamper-proof hinge features permanent, locked-in pins for added security.

Unbreakable glass-filled polycarbonate construction withstands years of job site abuse and harsh environmental exposure. Stainless steel mounting screws resist corrosion.

Stainless steel mounting screws resist corrosion.



WPG-1 and WPG-2



Molded-in label area for pre-printed or handwritten labels identifying circuits, ratings, and other data.

Pre-attached gaskets for easy installation and tight seal to panel or weatherproof box — with no misaligned or collapsed gaskets.

Lockable "bullnose" for OSHA Lockout/Tagout compliance.

We offer a complete line of durable, easy-to-install, and environment-resistant weatherproof products — for first-rate performance in worst-case applications.

Index

Device	Page Number
While-In-Use Covers	R-2, R-3
Cast While-In-Use Covers	R-4
Cast Weatherproof Covers	R-5 – R-7
Thermoplastic Covers	R-8 – R-11
Heavy Cast Aluminum Covers	R-11, R-12
Weatherproof Stainless Steel Covers	R-13
Weatherproof Kits	R-14
Single Gang Boxes	R-16
Two Gang Boxes	R-17
Three Gang Boxes & Deep Boxes	R-18
Round Boxes & Swimming Pool Junction Box	R-19
Cluster & Blank Covers	R-20
Lighting Accessories	R-21
Vapor Proof Lighting	R-22
Gaskets & Accessories	R-23
NEC Compliance	R-24

Pass & Seymour



Weatherproof Boxes & Covers While-In-Use Covers

The 2005 NEC Section 406.8(B)(1) requires that all 15 and 20 Amp, 125 and 250 Volt outdoor receptacles in wet locations have a cover that is weatherproof — even when a plug is inserted into the receptacle.

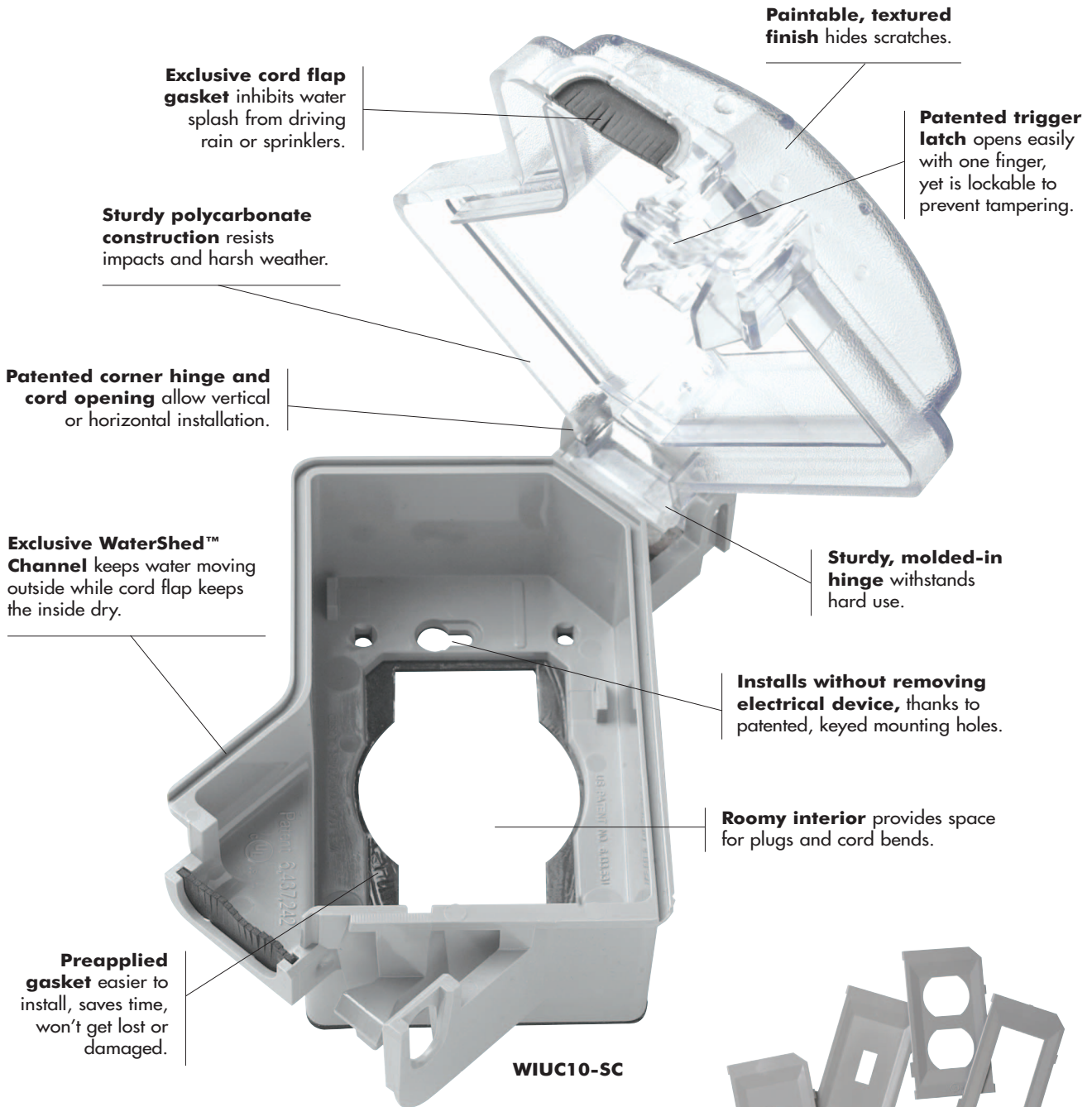

Shallow profile models have 1" shorter top lid than prior models.



Snap-in device plates require no tools to install and won't fall out. See chart for plates provided with each catalog number.

Weatherproof Boxes & Covers While-In-Use Covers

Pass & Seymour



Features

- Comply with NEC 2005 Section 406.8(B)(1) for wet location covers, and conform to NEMA 3R.
- Covers are self-closing as required by UL514C42.3.
- Covers mount vertically or horizontally.
- Body, cover, and plates made of polycarbonate.
- Gasket made of closed cell foam, neoprene blend regular density, UL Rated HBF.
- Mounting screws made of 302 stainless steel.
- Single receptacle plate available in 1.405" and 1.595" openings.
- Deep model available for 20A locking plugs.
- Shallow covers accommodate up to 14/3 AWG extension cords.
- New trigger latch opens easily with one finger.

SINGLE GANG COVERS

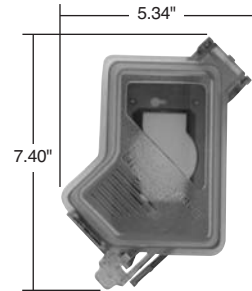

SINGLE GANG



SINGLE GANG SHALLOW



SINGLE GANG DEEP

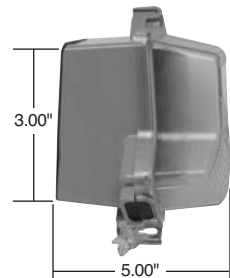

Catalog Number	Bottom Color	Top Color	Device Plates Provided	Plate Width	Package Quantity	3rd Party Compliance
Single Gang						
WIUC10-GL WIUC10-CL WIUC10-WL	Gray Clear White	Gray Clear White		2 3/8"	12	•
Single Gang Shallow						
WIUC10-SG WIUC10-SC WIUC10-SW WIUC10-SB	Gray Gray White White	Gray Clear White Clear		2 3/8"	14	•
Single Gang Deep						
WIUC10-DGL WIUC10-DCL WIUC10-DWL	Gray Gray White	Gray Clear White		2 3/8"	9	•
Two Gang						
WIUC20-GL WIUC20-CL WIUC20-WL	Gray Gray White	Gray Clear White		2"	8	•
Extra Plate Kits						
WIU10-PK WIU10-PKW	Gray White		Single Gang Plate Kit 	2 3/8"		•
WIU20-PK WIU20-PKW	Gray White		Two Gang Plate Kit 	2"		•

NEW

TWO GANG COVER

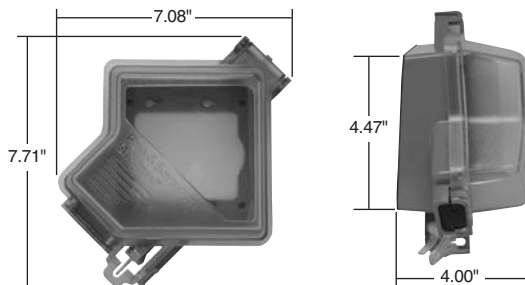

Weatherproof Boxes & Covers Cast While-In-Use Covers

Meets NEC 2005 Section 406.8(B)(1) suitable for wet locations.

All components baked-on electrostatic, polyester, powder paint coated prior to assembly for superior corrosion resistance.

Self-closing lids as required by UL514C42.3.

Heavy-duty die-cast zinc.

Gasket, stainless steel screws, and two metal mounting plates are supplied.

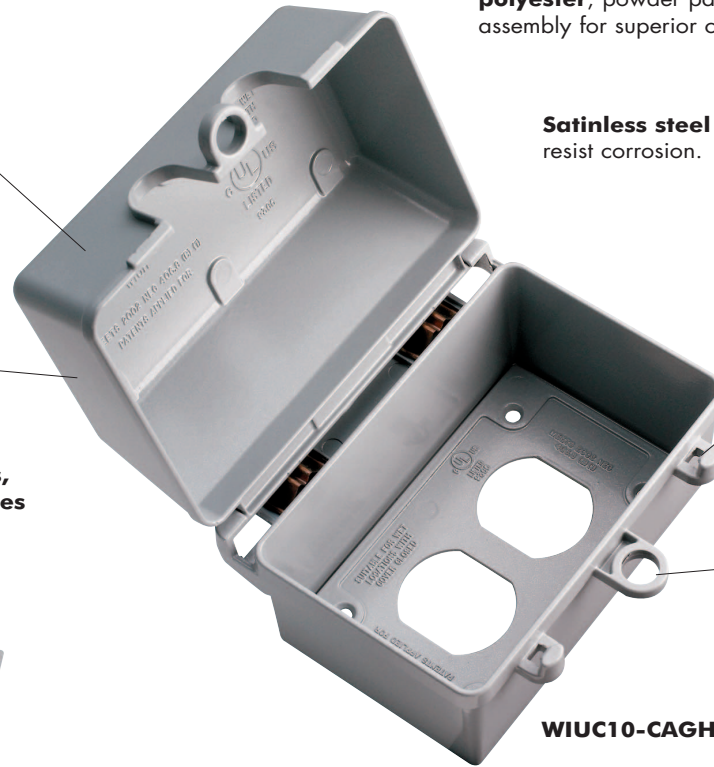

Satinless steel springs resist corrosion.

Cam action latch for secure closure and easy access.

Accepts a standard sized padlock.

WIUC10-CAGH

Catalog Number	Color	Device Plates Provided	Package Quantity	3rd Party Compliance
NEW Single Gang – Vertical				
WIUC10-CABRV	Bronze		12	•
WIUC10-CAGV	Gray			
WIUC10-CAWV	White			
NEW Single Gang – Horizontal				
WIUC10-CABRH	Bronze		12	•
WIUC10-CAGH	Gray			
WIUC10-CAWH	White			



WIUC10-CAGV

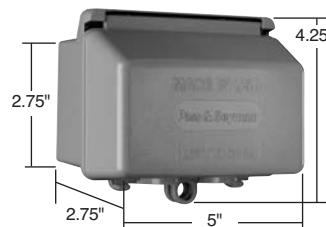

WIUC10-CAGH

Weatherproof Boxes & Covers









Cast Weatherproof Covers

Pass & Seymour

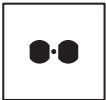

Features

- Broad line of single gang covers for receptacles and power outlets.
- High quality, made in U.S.A.
- Baked-on electrostatic, polyester, powder paint for superior scratch and corrosion resistance.
- Heavy-duty die-cast zinc.
- Stainless steel springs.
- Covers comply with 2005 NEC Section 406.8(A) and 406.8(B)(2).

Catalog Number	Description	Color	3rd Party Compliance	
			UL US	
One Gang				
 CA7-GH	Single Receptacle Horizontal – 1 Self-Closing Lid	Gray	•	
 CA7-GV CA7-BRV CA7-WV	Single Receptacle Vertical – 1 Self-Closing Lid	Gray Bronze White	•	
 CA8-GH CA8-BRH CA8-WH	Duplex Receptacle Horizontal – 2 Self-Closing Lids	Gray Bronze White	•	
 CA8-GJ	Oversized Duplex Receptacle Horizontal – 2 Self-Closing Lids Dimensions: H - 4.52", L - 4.58"	Gray	•	
 CA8-GV CA8-BRV CA8-WV	Duplex Receptacle Vertical – 1 Self-Closing Lid	Gray Bronze White	•	
 CA8-GVFS CA8-WVFS	Duplex Receptacle Vertical – 1 Self-Closing Lid 4 Screw Mounting	Gray White	•	
 CA721-G	Power Outlet – 1.625 Diameter Vertical – 1 Self-Closing Lid	Gray	•	
 CA725-G	Power Outlet – 1.750 Diameter Vertical – 1 Self-Closing Lid	Gray	•	
 CA723-G	Power Outlet – 2.125 Diameter Vertical – 1 Self-Closing Lid	Gray	•	

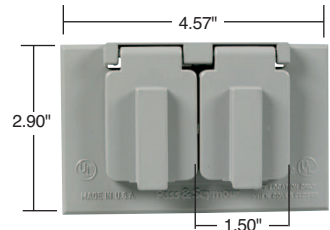

**Horizontal
2 Self-Closing Lids**



**Vertical
1 Self-Closing Lid**



**Horizontal
1 Self-Closing Lid**

Weatherproof Boxes & Covers

Cast Weatherproof Covers

Features

- Broad line of single gang covers for switches and GFCIs.
- High quality, made in U.S.A.
- Baked-on electrostatic, polyester, powder paint for superior scratch and corrosion resistance.
- Heavy-duty die-cast zinc.
- Stainless steel springs.
- Covers comply with 2005 NEC Section 406.8(A) and 406.8(B)(2).



**Horizontal
1 Self-Closing Lid**



**Vertical
1 Self-Closing Lid**

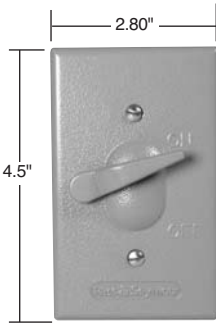

CA1-GL

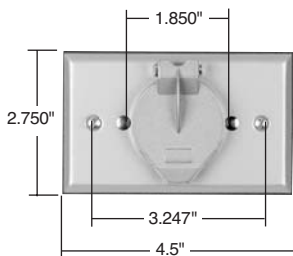

3778

Catalog Number	Description	Color	3rd Party Compliance
One Gang			
CA26-GH CA26-BRH CA26-WH	Decorator or GFCI Horizontal – 1 Self-Closing Lid	Gray Bronze White	•
CA26-GV CA26-BRV CA26-WV	Decorator or GFCI Vertical – 1 Self-Closing Lid	Gray Bronze White	•
CA1-G	Toggle Vertical – 1 Self-Closing Lid	Gray	•
CA1-GS	Toggle with 15A 120VAC Single Pole Toggle Switch Included Vertical – 1 Self-Closing Lid	Gray	•
CA1-GL CA1-BRL CA1-WL	Toggle Switch Cover – with Actuating Lever – Mounts Directly Over Switch	Gray Bronze White	•

Self-Closing Cover – Motor Base – Horizontal			
3778	Single with 15A 125V Recessed Flanged Inlet.	Gray	•

Weatherproof Boxes & Covers Cast Weatherproof Covers

Pass & Seymour



- | Features | |
|--|--|
| <ul style="list-style-type: none"> ■ Broad line of two gang covers for switches, receptacles, GFCIs, and power outlets. ■ High quality, made in U.S.A. ■ Baked-on electrostatic, polyester, powder paint for superior scratch and corrosion resistance. | <ul style="list-style-type: none"> ■ Heavy-duty die-cast zinc. ■ Stainless steel springs. ■ All covers have 2 self-closing lids. ■ Covers comply with 2005 NEC Section 406.8(A) and 406.8(B)(2). |

Catalog Number	Description	Color	3rd Party Compliance	
			UL US	
Two Gang				
CA82-G CA82-BR CA82-W	2 Duplex Receptacles	Gray Bronze White	•	
CA72-G	2 Single Receptacles	Gray	•	
CA78-G	1 Single/1 Duplex 4 Screw Mounting	Gray	•	
CA726-G	1 Single/1 Decorator 4 Screw Mounting	Gray	•	
CA262-G	2 Decorator 4 Screw Mounting	Gray	•	
CA268-G CA268-BR CA268-W	1 Decorator/1 Duplex 4 Screw Mounting	Gray Bronze White	•	
CA17-G	1 Toggle/1 Single 4 Screw Mounting	Gray	•	
CA18-G	1 Toggle/1 Duplex 4 Screw Mounting	Gray	•	
CA126-GRY	1 Toggle/1 Decorator 4 Screw Mounting	Gray	•	
CA2-G CA2-BR CA2-W	2 Toggles 4 Screw Mounting	Gray Bronze White	•	
CA2-GS	2 Toggles with 2 15A 120VAC Single Pole Toggle Switches Included 4 Screw Mounting	Gray	•	

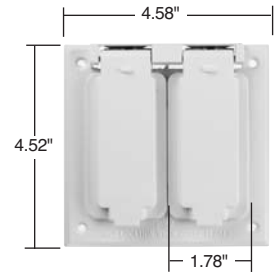

Two Gang Cover

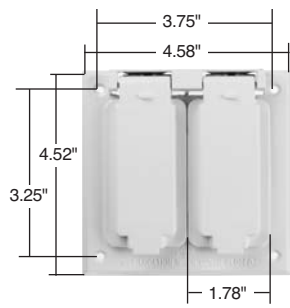

Two Gang Cover
4 Screw Mounting

Weatherproof Boxes & Covers Thermoplastic Covers

Features

- Broad line of single gang covers for switches, receptacles, GFCIs and power outlets.
- Clear polycarbonate lid with reinforced thermoplastic base.
- Covers comply with 2005 NEC Section 406.8(A) and 406.8(B)(2).

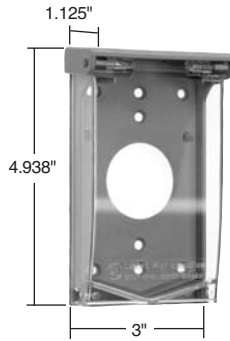

3720-FS

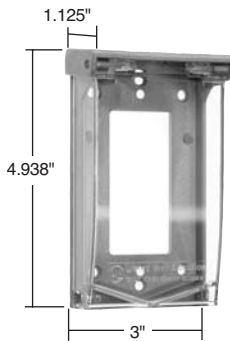

3723-FS

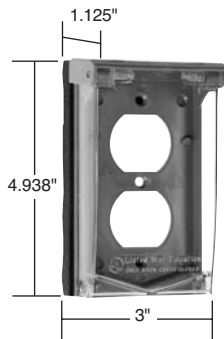

3710

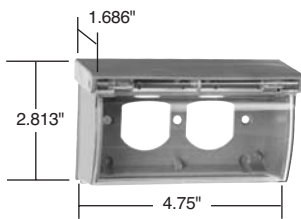

3700

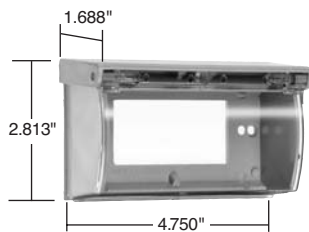

3703

Catalog Number	Description	Gasket Thickness	3rd Party Compliance	
			UL	SR
Self-Closing Covers – Clear Polycarbonate Lid Vertical Two Screw Mounting – Padlockable				
3710	Duplex RV use Gray Base	3/8"	•	•
3720	Single Receptacle 1.40" Diameter Gray Base	3/8"	•	•
3723	Decorator RV use Gray Base	3/8"	•	•
Self-Closing Covers – Clear Polycarbonate Lid Vertical Four Screw Mounting – Padlockable				
3710-FS	Duplex Receptacle Gray Base	3/32"	•	•
3720-FS	Single Receptacle 1.40" Diameter Gray Base	3/32"	•	•
3723-FS	Decorator or GFCI Gray Base	3/32"	•	•
3722-FS	Power Outlet, 1.60" Diameter Gray Base	3/32"	•	•
3724-FS	Power Outlet, 1.73" Diameter Gray Base	3/32"	•	•
3795	Power Outlet, 2.13" Diameter Gray Base	3/8"	•	•
Self-Closing Covers – Clear Polycarbonate Lid Horizontal Two Screw Mounting				
3700	Duplex Receptacle Gray Base	3/32"	•	•
3703	Decorator Gray Base	3/32"	•	•
3703-T	Decorator RV Use Gray Base	3/8"	•	•
3703-TCW	Decorator RV Use Colonial White Base	3/8"	•	•
Self-Closing Covers – Clear Polycarbonate Lid Horizontal Four Screw Mounting				
3700-FS	Duplex Receptacle Gray Base	3/32"	•	•
3703-FS	Decorator Receptacle Gray Base	3/32"	•	•

Weatherproof Boxes & Covers Thermoplastic Covers

Pass & Seymour



Features	
<ul style="list-style-type: none"> ■ Broadest line in the industry. ■ All covers are self-closing with two flip lids. 	<ul style="list-style-type: none"> ■ Covers comply with 2005 NEC Section 406.8(A) and 406.8(B)(2).

Catalog Number	Description	Gasket Thickness	3rd Party Compliance	
			UL	SF
Outdoor Assemblies and Special Covers For Mobile Homes, Manufactured and Modular Housing, and RV Use – Horizontal Installation with Two Self-Closing Flip Lids				
3780-SCFBX	3232 Duplex Receptacle, Gasket and Flanged Box, Gray with Black Gasket	1/8"	•	
3780-SCFBXCW	3232 Duplex Receptacle, Gasket and Flanged Box, Colonial White with Black Gasket	1/8"	•	
3780-SCFBXWH	3232 Duplex Receptacle, Gasket and Flanged Box, White with White Gasket	1/8"	•	
3780-SCMH	3232 Duplex Receptacle & Gasket, Gray with Black Gasket	3/8"	•	
3780-SCMHCW	3232 Duplex Receptacle & Gasket, Colonial White with Black Gasket	3/8"	•	
3780-SCMHBG	3232 Duplex Receptacle & Gasket, Beige with Black Gasket	3/8"	•	
3780-SCMHW	3232 Duplex Receptacle & Gasket, White with White Gasket	3/8"	•	
3780-SCLV	3/8" Round Openings for 2 Coaxial Connections, Gray with Black Gasket	1/8"	•	•
3780-SCLVBG	3/8" Round Openings for 2 Coaxial Connections, Beige with Black Gasket	1/8"	•	•
3780-SCLVCW	3/8" Round Openings for 2 Coaxial Connections, Colonial White with Black Gasket	1/8"	•	•
3780-SCLVWH	3/8" Round Openings for 2 Coaxial Connections, White with White Gasket	1/8"	•	•

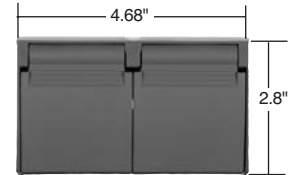

3780 Series



FBOX1

Catalog Number	Description	Color	3rd Party Compliance	
			UL	SF
Flanged Boxes for Horizontal or Vertical Installation				
FBOX1	Flanged Box – 18.5 Cubic Inch Minimum Opening Size 2.5" x 4.1" Depth 3.0"	Gray	•	
FBOX1WH	Flanged Box – 18.5 Cubic Inch Minimum Opening Size 2.5" x 4.1" Depth 3.0"	White	•	

Weatherproof Boxes & Covers

Thermoplastic Covers

Features

- Broadest line in the industry.
- Covers comply with 2005 NEC Section 406.8(A) and 406.8(B)(2).
- 3780 series have two flip lids.
- 3726 series have a single flip lid.

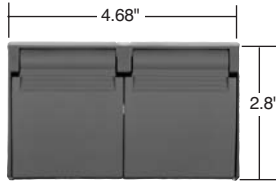



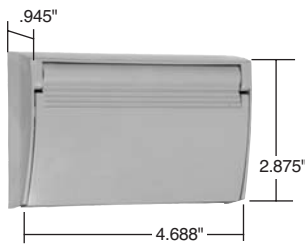



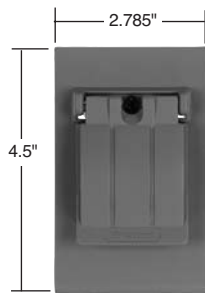





3780 Series



3726 Series



3760

Catalog Number	Description	Gasket Thickness	3rd Party Compliance	
			UL	CSA
Horizontal Self-Closing Flip Lids				
 3780-SC	Duplex, Gray with Black Gasket	1/8"	•	•
 3780-SCCW	Duplex, Colonial White with White Gasket	1/8"	•	•
 3780-SCWH	Duplex, White with White Gasket	1/8"	•	•
 3780-SCBG	Duplex, Beige with Black Gasket	1/8"	•	•
 3780-SCCWT	Duplex, Colonial White with Black Gasket	3/8"	•	•
 3726-SC	Decorator or GFCI, Gray with Black Gasket	3/32"	•	•
 3726-SCBG	Decorator or GFCI, Beige with Black Gasket	3/32"	•	•
 3726-SCCW	Decorator or GFCI, Colonial White with Black Gasket	3/32"	•	•
 3726-SCWH	Decorator or GFCI, White with White Gasket	3/32"	•	•
Horizontal Single Cover Self-Closing Flip-Lid				
 3770-SC	Single Receptacle 1.405" Diameter, Gray	3/32"	•	•
Vertical Single Cover Three Position Flip-Lid (Closed, Opened 90° or Opened 180°)				
 3760	Single Receptacle 1.563" Diameter, Gray	3/32"	•	•
 3763	Cover with 5251-I Single Receptacle, 15A-125V, Gray	3/32"	•	•
Horizontal Reinforced Thermoplastic Two Position Flip-Lids, (Closed or Opened 90°)				
 3780	Duplex, Gray with Black Gasket, 2 Flip Lids	1/8"	•	•

Weatherproof Boxes & Covers

Thermoplastic/ Heavy Cast Aluminum Covers

Specification Grade

Pass & Seymour



Weatherproof Boxes & Covers

Thermoplastic/Heavy Cast Aluminum Covers

Industrial Grade Weatherproof Covers

Features	
<ul style="list-style-type: none"> Unbreakable glass-filled polycarbonate construction to withstand years of job site abuse and harsh environmental exposure. Stainless steel mounting screws also resist corrosion. Covers comply with 2005 NEC Section 406.8(A) and 406.8(B)(2). Molded-in label area (2.8 sq. in.) for pre-printed or handwritten labels for identification of circuits, ratings, and other application data. 	<ul style="list-style-type: none"> WPG-1 and WPG-2 have lockable "bullnose" for OSHA locktag/tagout compliance. Covers fit all competitive inlets and outlets. Pre-attached gaskets for easy installation and tight seal to panel or weatherproof box – with no misaligned or collapsed gaskets. Tamper-proof hinge features permanent, locked-in pins for added security.

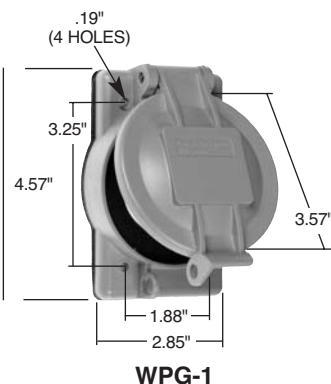

WPG-1

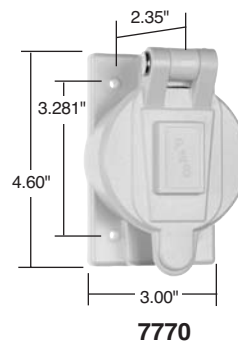

7770

Catalog Number	Description	Color	3rd Party Compliance	
			UL	SF
Thermoplastic Weatherproof Covers for Flanged Inlet/Outlet				
WPG-1	1.96" Diameter Opening to Accommodate 15/20A Straight Blade, 15A Turnlok, 20403 Power Interrupter	Gray	•	•
WPG-2	2.32" Diameter Opening to Accommodate 20A Turnlok, 30A Turnlok	Gray	•	•
Thermoplastic Weatherproof Cover for Single Receptacles				
7770	2.38" Diameter Opening to Accommodate 50A Turnlok (non-lockout)	Yellow	•	

Heavy Cast Aluminum Covers – Flush Enclosures

Features	
<ul style="list-style-type: none"> Adapter, frame, and cover are heavy cast aluminum. No. 8-32 screws hold assembly firmly in place. Covers comply with 2005 NEC Section 406.8(A) and 406.8(B)(2). Mortar keys provide positive holding means within wall. 	<ul style="list-style-type: none"> Neoprene gasket seals cover to frame. Moisture and dust cannot enter enclosure. Two keys provided for cam lock. Purchase enclosure and mounting plate separately Mounts on 4" or 4-11/16" box.



4600

Note: All locks keyed the same.

Catalog Number	Description	Color	3rd Party Compliance	
			UL	SF
Mortared-in Applications				
	4600 Enclosure Only, without Mounting Plate	Gray	•	•
	4600-1P Mounting Plate for Toggle Switch	Gray	•	•
	4600-7P Mounting Plate for Single Receptacle Diameter: 1.406"	Gray	•	•
	4600-8P Mounting Plate for Duplex Receptacle	Gray	•	•
	4600-26P Mounting Plate for Decorator/GFCI	Gray	•	•
	4609 Replacement Key for Enclosure		•	•

Pass & Seymour



Weatherproof Boxes & Covers

Heavy Cast Aluminum Covers

Specification Grade



4504
4512
7420
3393

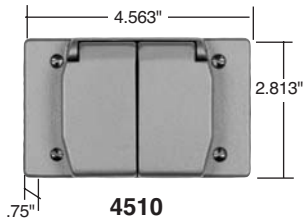

4510

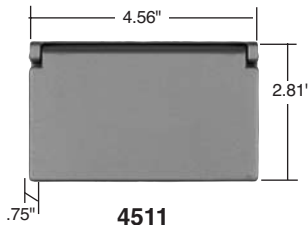



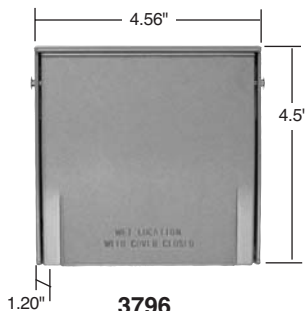

4511



3796
3797



Features

- Extremely durable for hard-use institutional applications.
- Spring-loaded covers close automatically when plugs are removed.
- Die-cast copper-free aluminum construction.
- Stainless steel springs.
- Screws and spring covers are chrome-plated brass.
- Baked-on lacquer finish.
- Heavy rubber gaskets provide positive seal.
- All covers below are for 4 screw mounting only.
- Comply with 2005 NEC Section 406.8(A) and 406.8(B)(2).

Catalog Number	Description	Color	3rd Party Compliance	
			UL	SF
Heavy Cast Aluminum Covers – One Gang				
	4504 Duplex Receptacle Vertical	Gray	•	•
	4510 Duplex Receptacle, 2 Doors Horizontal	Gray	•	•
	4511 Decorator/GFCI Horizontal	Gray	•	•
	4512 Decorator/GFCI Vertical	Gray	•	•
	7420 1 Gang Power Outlet 1.593" max. Diameter Vertical	Gray	•	•
	3393 1 Gang Power Outlet 1.750" max. Diameter Vertical	Gray	•	•

Features

- Heavy-duty die cast aluminum covers and plate.
- 3/32" gasket included.
- Stainless steel mounting screws.

Catalog Number	Description	Color	3rd Party Compliance	
			UL	SF
Multigang Covers – Outdoor				
	3796 2 Gang Power Outlet (2.156" Diameter Opening)	Gray	•	•
	3797 2 Gang Power Outlet (2.656" Diameter Opening)	Gray	•	•

Weatherproof Boxes & Covers



Weatherproof Stainless Steel Covers

Specification Grade

Pass & Seymour



Features	
<ul style="list-style-type: none"> Covers comply with 2005 NEC Section 406.8(A) and 406.8(B)(2). Plate is Type 302 Stainless Steel for corrosion resistance. 	<ul style="list-style-type: none"> Ideal for hard-use and corrosive applications. Aesthetically pleasing.

Catalog Number	Description	3rd Party Compliance	
		UL	SP
Stainless Steel Covers			
	WP13 1 Gang Blank (Box Mounted) Gasketed	•	•
	WP13-FS For 4 Screw Mounting	•	•
	WP23 2 Gang Blank (Box Mounted) Gasketed	•	•

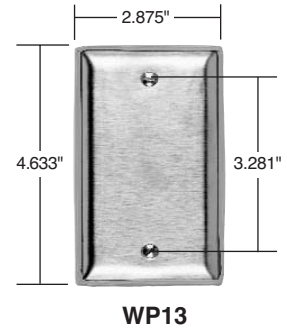

Features	
<ul style="list-style-type: none"> Covers comply with 2005 NEC Section 406.8(A) and 406.8(B)(2). Plate is Type 302 Stainless Steel for corrosion resistance. Transparent silicone rubber mat seals plate and opening from contamination. Switch easily actuated through flexible silicone bubble. 	<ul style="list-style-type: none"> Silicone mat maintains pliability from -100° F to +250° F. Mat is resistant to grease, water, steam, detergents, aging, and ozone.

Catalog Number	Mat Catalog Number	Description	3rd Party Compliance	
			UL	SP
Stainless Steel Covers				
4515	4515-GAS	Round mat, mounts to Standard Switch Box	•	•
4515-FS	4515-FSGAS	Round mat, 4 Screw Box mounting	•	•
4516	4516-GAS*	Rectangular mat, mounts to Standard Switch Box (includes #348 strap for Despard switches)	•	•
4517		Rectangular mat, 4 Screw Box mounting	•	•

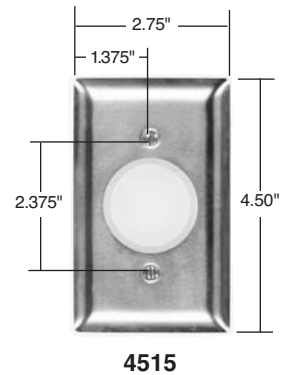

*For use with both 4516 and 4517.

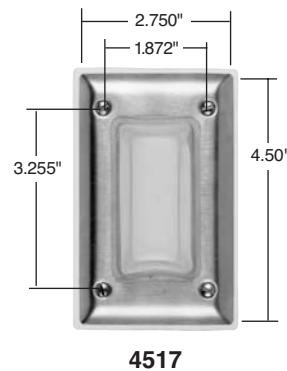
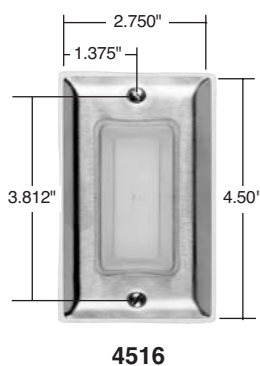
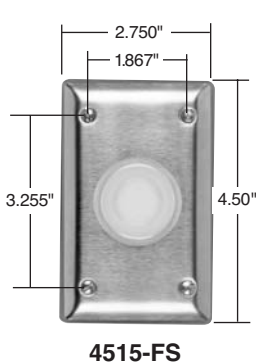

For Dustproof Stainless Steel Covers, see Page S-26.

Weatherproof Boxes & Covers Weatherproof Kits

Easy-to-install, self-contained kits include everything needed for installation – gaskets, plugs, and hardware.



WPWIUKIT-C



WPGFIKIT



WPOUTKIT

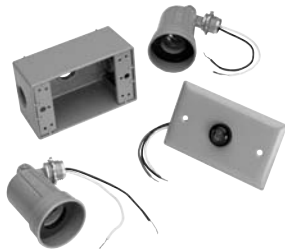

WPDTDKIT



WPFLDKIT



Clam-shell packaging designed for hanging displays.

Catalog Number	Color	Description	Components	3rd Party Compliance cULus
Weatherproof Kits				
WPWIUKIT-C	Clear	Weatherproof While-in-Use Safety Outlet (GFCI) Kit includes	1594-GRY, WPB23, WIUC10-CL	•
WPWIUKIT-W	White	GFCI, box, and While-In-Use cover	1594-W, WPB23-W, WIUC10-WL	•
WPWIUKIT-SC	Clear	Weatherproof Shallow While-in-Use Safety Outlet (GFCI) Kit includes	1594-GRY, WPB23, WIUC10-SC	•
WPWIUKIT-SW	White	GFCI, box, and shallow While-In-Use cover	1594-W, WPB23-W, WIUC10-SW	•
WPGFIKIT	Gray	Weatherproof Safety Outlet (GFCI) Kit includes GFCI,	1594-GRY, WPB23, CA26-GH	•
WPGFIKIT-BR	Bronze	box, and cover	1594, WPB23-BR, CA26-BRH	•
WPGFIKIT-W	White		1594-W, WPB23-W, CA26-WH	•
WPOUTKIT	Gray	Weatherproof Outlet Kit includes	3232-I, WPB23, CA8-GH	•
WPOUTKIT-BR	Bronze	outlet, box, and cover	3232-I, WPB23-BR, CA8-BRH	•
WPOUTKIT-W	White		3232W, WPB23-W, CA8-WH	•
WPDTDKIT	Gray	Dusk-Til-Dawn Dual Floodlight Kit includes box, cover, lampholders,	WPB33, (2) PAR1, plate with sensor	•
WPDTDKIT-BR	Bronze	and plate with sensor	WPB33-BR, (2) PAR1-BR, plate with sensor	•
WPDTDKIT-W	White		WPB33-W, (2) PAR1-W, plate with sensor	•
WPFLDKIT	Gray	Weatherproof Dual Floodlight Kit includes box, cover, and	WPRB25, (2) PAR1, WPRB12	•
WPFLDKIT-BR	Bronze	lampholders	WPRB25-BR, (2) PAR1-BR, WPRB12-BR	•
WPFLDKIT-W	White		WPRB25-W, (2) PAR1-W, WPRB12-W	•

Cast Weatherproof Boxes & Covers

Pass & Seymour



Product assembled after painting for complete corrosion resistance.

Stainless steel springs.

Baked-on electrostatic, polyester, powder paint, for superior scratch- and corrosion-resistant finish.

Covers available in 1 & 2 gang in a variety of configurations.



No rough edges.

CA8-GH

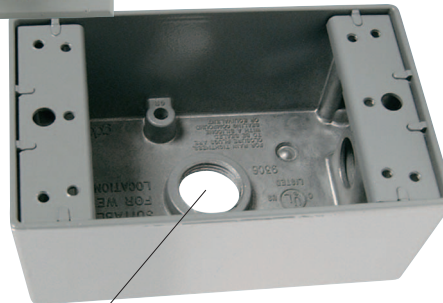

Available in gray, white and bronze.

WPB23

Available in standard and deep configurations.

Available in 1/2" and 3/4" hub sizes, from 3 to 6 hole configurations.

UL Listed, for wet and/or damp locations with appropriate cover.

Boxes available in 1, 2 & 3 gang.

Weatherproof Boxes & Covers





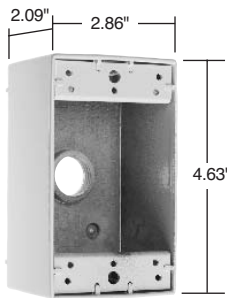

Weatherproof Boxes

Features

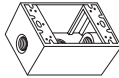
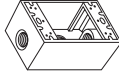
- Wide range of sizes, depths, and gangs.
- Baked-on electrostatic, polyester, powder paint for superior scratch and corrosion resistance.
- 2 closure plugs and mounting lugs furnished with all boxes.
- UL Listed for wet and/or damp locations with appropriate cover.
- Designed for both interior and exterior applications.
- Will accept standard 4 screw mounting covers and single gang weatherproof covers.
- Simply strike desired knockout studs with a sharp hammer blow for clean mounting holes.
- Heavy die-cast aluminum.

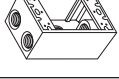
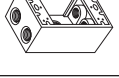
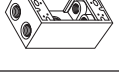
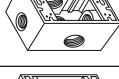

Single Gang Box

Catalog Number	Description	Color	3rd Party Compliance	
			UL	SR
Single Gang Boxes				
 WPB23 WPB23-BR WPB23-W	3 Hole 1/2", 18.5 Cu. In. (1 Hole Each End, 1 Hole in Back)	Gray Bronze White	•	•
 WPB33 WPB33-BR WPB33-W	3 Hole 3/4", 18.5 Cu. In. (1 Hole Each End, 1 Hole in Back)	Gray Bronze White	•	•
 WPB24 WPB24-BR WPB24-W	4 Hole 1/2", 18.0 Cu. In. (2 Holes One End, 1 Hole Other End, 1 Hole in Back)	Gray Bronze White	•	•
 WPB34 WPB34-BR WPB34-W	4 Hole 3/4", 18.0 Cu. In. (2 Holes One End, 1 Hole Other End, 1 Hole in Back)	Gray Bronze White	•	•
 WPB25 WPB25-BR WPB25-W	5 Hole 1/2", 17.0 Cu. In. (2 Holes Each End, 1 Hole in Back)	Gray Bronze White	•	•
 WPB35	5 Hole 3/4", 17.0 Cu. In. (2 Holes Each End, 1 Hole in Back)	Gray	•	•
 WPB26 WPB26-BR WPB26-W	5 Hole 1/2", 17.0 Cu. In. (1 Hole Each End, 1 Hole Each Side, 1 Hole in Back)	Gray Bronze White	•	•
 WPB36	5 Hole 3/4", 16.8 Cu. In. (1 Hole Each End, 1 Hole Each Side, 1 Hole in Back)	Gray	•	•
 WPB24-H	6 Hole 1/2", 18.0 Cu. In. (2 Holes in Bottom, 1 Hole in Top, 1 Hole in Back, 1 Hole each End)	Gray	•	•
 WPB34-H	6 Hole 3/4", 18.5 Cu. In. (2 Holes in Bottom, 1 Hole in Top, 1 Hole in Back, 1 Hole each End)	Gray	•	•

Weatherproof Boxes & Covers

Weatherproof Boxes

Pass & Seymour



Features

- Wide range of sizes, depths, and gangs.
- Baked-on electrostatic, polyester, powder paint for superior scratch and corrosion resistance.
- 2 closure plugs and mounting lugs furnished with all boxes.
- UL Listed for wet and/or damp locations with appropriate cover.
- Designed for both interior and exterior applications.
- Will accept standard two gang weatherproof covers.
- Simply strike desired knockout studs with a sharp hammer blow for clean mounting holes.
- Heavy die-cast aluminum.

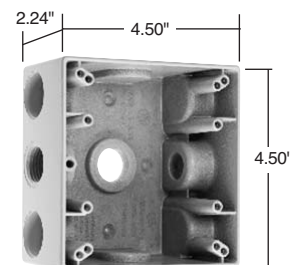

Two Gang Box

Catalog Number	Description	Color	3rd Party Compliance	
			UL	SF
Two Gang Boxes				
WPB232 WPB232-W	2 Gang – 3 Hole 1/2", 30.5 Cu. In. (1 Hole Each End, 1 Hole in Back)	Gray White	•	•
WPB332	2 Gang – 3 Hole 3/4", 30.5 Cu. In. (1 Hole Each End, 1 Hole in Back)	Gray	•	•
WPB242 WPB242-BR WPB242-W	2 Gang – 4 Hole 1/2", 30.5 Cu. In. (2 Holes One End, 1 Hole Other End, 1 Hole in Back)	Gray Bronze White	•	•
WPB342 WPB342-BR WPB342-W	2 Gang – 4 Hole 3/4", 30.5 Cu. In. (2 Holes One End, 1 Hole Other End, 1 Hole in Back)	Gray Bronze White	•	•
WPB252	2 Gang – 5 Hole 1/2", 30.5 Cu. In. (2 Holes Each End, 1 Hole in Back)	Gray	•	•
WPB352	2 Gang – 5 Hole 3/4", 30.5 Cu. In. (2 Holes Each End, 1 Hole in Back)	Gray	•	•
WPB262	2 Gang – 5 Hole 1/2", 30.5 Cu. In. (1 Hole Each End, 1 Hole Each Side, 1 Hole in Back)	Gray	•	•
WPB362	2 Gang – 5 Hole 3/4", 30.5 Cu. In. (1 Hole Each End, 1 Hole Each Side, 1 Hole in Back)	Gray	•	•
WPB272	2 Gang – 6 Hole 1/2", 30.5 Cu. In. (2 Holes One End, 1 Hole Other End, 1 Hole Each Side, 1 Hole in Back)	Gray	•	•
WPB372	2 Gang – 6 Hole 3/4", 30.5 Cu. In. (2 Holes One End, 1 Hole Other End, 1 Hole Each Side, 1 Hole in Back)	Gray	•	•
WPB276	2 Gang – 6 Hole 1/2", 30.5 Cu. In. (3 Holes One Side, 2 Holes Other Side, 1 Hole in Back)	Gray	•	•
WPB376	2 Gang – 6 Hole 3/4", 30.5 Cu. In. (3 Holes One Side, 2 Holes Other Side, 1 Hole in Back)	Gray	•	•
WPB282	2 Gang – 7 Hole 1/2", 30.5 Cu. In. (2 Holes Each End, 1 Hole Each Side, 1 Hole in Back)	Gray	•	•
WPB382	2 Gang – 7 Hole 3/4", 30.5 Cu. In. (2 Holes Each End, 1 Hole Each Side, 1 Hole in Back)	Gray	•	•
WPB287	2 Gang – 7 Hole 1/2", 30.5 Cu. In. (3 Holes Each Side, 1 Hole in Back)	Gray	•	•
WPB387	2 Gang – 7 Hole 3/4", 30.5 Cu. In. (3 Holes in Each Side, 1 Hole in Back)	Gray	•	•

Weatherproof Boxes & Covers

Weatherproof Boxes

Features

- Wide range of sizes, depths, and gangs.
- Baked-on electrostatic, polyester, powder paint for superior scratch and corrosion resistance.
- 2 closure plugs and mounting lugs furnished with all boxes.
- UL Listed for wet and/or damp locations with appropriate cover.
- Designed for both interior and exterior applications.
- Simply strike desired knockout studs with a sharp hammer blow for clean mounting holes.
- Heavy die-cast aluminum.

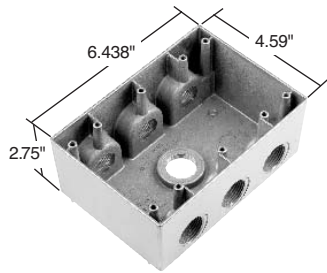

Three Gang Box

Catalog Number	Description	Color	3rd Party Compliance	
			UL	SR
Three Gang Boxes				
WPB373	3 Gang – 7 Hole 3/4", 59.8 Cu. In. (3 Holes Each Side, 1 Hole in Back)	Gray	•	•
WPB473	3 Gang – 7 Hole 1", 59.8 Cu. In. (3 Holes Each Side, 1 Hole in Back)	Gray	•	•

Features

- Baked-on electrostatic, polyester, powder paint for superior scratch and corrosion resistance.
- 4 closure plugs and mounting lugs furnished with all boxes.
- UL Listed for wet and/or damp locations with appropriate cover.
- Designed for both interior and exterior applications.
- Will accept standard three-gang weatherproof covers.
- Simply strike desired knockout studs with a sharp hammer blow for clean mounting holes.
- Heavy die-cast aluminum.

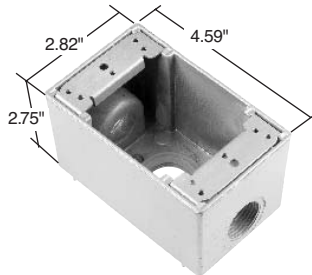

1 Gang Deep Box

1 Gang Deep Boxes				
WPBD23 WPBD23-BR WPBD23-W	1 Gang Deep – 3 Hole 1/2", 23 Cu. In. with Threaded Holes (1 Hole Each Side, 1 Hole in Back)	Gray Bronze White	•	•
WPBD33 WPBD33-BR WPBD33-W	1 Gang Deep – 3 Hole 3/4", 23 Cu. In. with Threaded Holes (1 Hole Each Side, 1 Hole in Back)	Gray Bronze White	•	•
WPBD43	1 Gang Deep – 3 Hole 1", 23 Cu. In. with Threaded Holes (1 Hole Each Side, 1 Hole in Back)	Gray	•	•

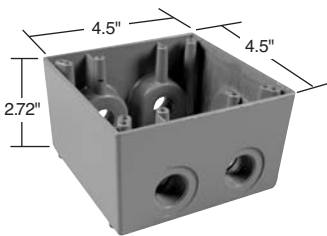

2 Gang Deep Box

2 Gang Deep Boxes				
WPBD252	2 Gang Deep – 5 Hole 1/2", 37 Cu. In. with Threaded Holes (2 Holes Each End, 1 Hole in Back)	Gray	•	•
WPBD352	2 Gang Deep – 5 Hole 3/4", 37 Cu. In. with Threaded Holes (2 Holes Each End, 1 Hole in Back)	Gray	•	•
WPBD452	2 Gang Deep – 5 Hole 1", 37 Cu. In. with Threaded Holes (2 Holes Each End, 1 Hole in Back)	Gray	•	•

Weatherproof Boxes & Covers

Weatherproof Round Boxes & Swimming Pool Junction Box

Pass & Seymour



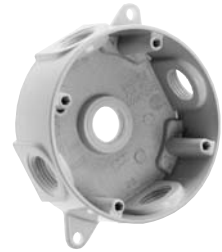

Features – 4" Round Die-Cast Aluminum Boxes

- Baked-on electrostatic, polyester, powder paint for superior scratch and corrosion resistance.
- 4 closure plugs and mounting lugs furnished with all boxes.
- UL Listed for wet and/or damp locations with appropriate cover.
- Designed for both interior and exterior applications.
- Heavy die-cast aluminum.



WPRB25

Catalog Number	Description	Color	3rd Party Compliance	
			UL	SF
4" Round Die-Cast Aluminum Boxes				
 WPRB25 WPRB25-BR WPRB25-W	Round Cast Box – 5 Hole 1/2", 16.1 Cu. In., 4 Plugs Furnished	Gray Bronze White	•	•
 WPRB35 WPRB35-BR WPRB35-W	Round Cast Box – 5 Hole 3/4" 16.1 Cu. In., 4 Plugs Furnished	Gray Bronze White	•	•

Catalog Number	Description	Color	3rd Party Compliance	
			UL	SF
Swimming Pool Junction Box				
WPBJ22	22 cu. in. Brass Base and Thermoplastic Cover. Meets NEC® Article 680. Two 3/4" Hubs, one 1" Hub. Four Ground Posts, Gasket, and Mounting Screws Included.	Gray	•	•

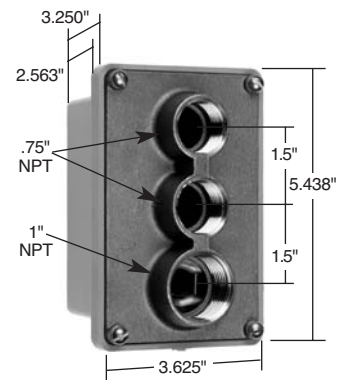

WPBJ22

Weatherproof Boxes & Covers Cluster & Blank Covers

Features

- Wide range of rectangular and round covers.
- Baked-on electrostatic, polyester, powder paint for superior scratch and corrosion resistance.
- Kits available combining fixtures, lamp covers, and accessories.



WPB11







WPRB1



WPRB12

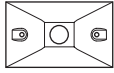
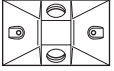
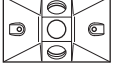

WPRB13

Catalog Number	Description	Color	3rd Party Compliance	
			UL	SR
Outdoor Lamp Cluster Covers for Single Gang Boxes				
 WPB11 WPB11-BR WPB11-W	Rectangular Single Gang Cover 1 Hole 1/2"	Gray Bronze White	•	•
 WPB12 WPB12-BR WPB12-W	Rectangular Single Gang Cover 2 Hole 1/2"	Gray Bronze White	•	•
 WPB13 WPB13-BR WPB13-W	Rectangular Single Gang Cover 3 Hole 1/2", 2 Plugs Furnished	Gray Bronze White	•	•
4" Round Outdoor Cluster Covers				
 WPRB1 WPRB1-BR WPRB1-W	Round Blank Cover with Gasket and Screws	Gray Bronze White	•	
 WPRB11 WPRB11-BR WPRB11-W	Round Cover – 1 Hole 1/2" with Gasket and Screws	Gray Bronze White	•	•
 WPRB12 WPRB12-BR WPRB12-W	Round Cover – 2 Hole 1/2" with Gasket and Screws	Gray Bronze White	•	•
 WPRB13 WPRB13-BR WPRB13-W	Round Cover – 3 Hole 1/2" with Gasket and Screws	Gray Bronze White	•	•

Features

- Designed for both interior and exterior applications.
- Universal aluminum mounting plates.
- Gray, bronze and white models have baked-on electrostatic, polyester, powder paint for superior scratch and corrosion resistance.

Catalog Number	Description	Color	3rd Party Compliance	
			UL	SR
Blank Covers				
 WPB1 WPB1-G WPB1-BR WPB1-W	1 Gang Blank Aluminum Cover with Gasket and Screws	Brushed Aluminum Gray Bronze White	•	•
 WPB2 WPB2-G WPB2-BR WPB2-W	2 Gang Blank Aluminum Cover with Gasket and Screws	Brushed Aluminum Gray Bronze White	•	•
 WPB3	3 Gang Blank Aluminum Cover with Gasket and Screws	Brushed Aluminum	•	•

Weatherproof Boxes & Covers Lighting Accessories

Pass & Seymour



Features

- Medium base heat resistant.
- Fits 1/2" threaded outlet.
- Seal gasket included.
- Adjustable through 180°.
- Complete range of lamp covers in gray and white.
- Corrosion-resistant finish.



PAR1-W



WPLKIT2



WPLKIT4



GARD3-BK

Catalog Number	Description	Color	3rd Party Compliance	
Die-Cast Outdoor Lampholder				
PAR1	Outdoor Lampholder	Gray	•	
PAR1-W	Outdoor Lampholder	White	•	
PAR1-BR	Outdoor Lampholder	Bronze	•	

Outdoor Lampholder Kits

WPLKIT1	Kit includes (1) WPRB13 and (2) PAR1 Lampholders	Gray	•	
WPLKIT2	Kit includes (1) WPRB13-W and 2 PAR1-W Lampholders	White	•	
WPLKIT3	Kit includes (1) WPB13 and 2 PAR1 Lampholders	Gray	•	
WPLKIT4	Kit includes (1) WPB13-W and 2 PAR1-W Lampholders	White	•	

Outdoor Garden Lamps & Accessories

GARD3-GR	3 Tier Garden Lamp	Green	•	•
GARD3-BK	3 Tier Garden Lamp	Black	•	•
GARD4-GR	4 Tier Garden Lamp	Green	•	•
GARD4-BK	4 Tier Garden Lamp	Black	•	•
GLOBE3	Replacement Globe – 3 Tier Lamp	Clear		
GLOBE4	Replacement Globe – 4 Tier Lamp	Clear		
SPIKE1	Male Spike	Gray		
SPIKE2	Female Spike	Gray		

Pass & Seymour



Weatherproof Boxes & Covers Vapor Proof Lighting



VPP100-G
VPP200-G



VPC100-G
VPC200-G



VPW100-G
VPW200-G



VPG100
VPG200



VG100
VG200

- Features**
- Cast metal guards for greater impact resistance.
 - Easy-to-install with time saving features.
 - Lights include round cast box, lampholder, glass globe, guard, and hardware.
 - High-quality castings eliminate sharp edges.
 - Dual rubber gaskets provide complete vapor proof seal.
 - 4 plugs furnished with wall and ceiling mounts.

Catalog Number	Description	Color	3rd Party Compliance
			UL
100 Watt			
VPW100-G	Wall Mount, 5 Hole 1/2"	Gray	•
VPP100-G	Pendant Mount, 1/2" NPT Top Hub	Gray	•
VPC100-G	Ceiling Mount, 5 Hole 1/2"	Gray	•
200 Watt			
VPW200-G	Wall Mount, 5 Hole 1/2"	Gray	•
VPP200-G	Pendant Mount, 1/2" NPT Top Hub	Gray	•
VPC200-G	Ceiling Mount, 5 Hole 1/2"	Gray	•
Globes			
VPG100	Clear Globe – 100 Watt	Clear	
VPG200	Clear Globe – 200 Watt	Clear	
Cast Guard			
VG100	Cast Guard – 100 Watt	Gray	
VG200	Cast Guard – 200 Watt	Gray	

Weatherproof Boxes & Covers Gaskets & Accessories

Pass & Seymour



GASKET38



GASKET3726



GASKET3780



WPGAS100

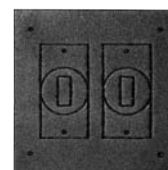

WPGAS101

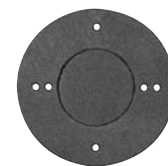

WPGASR101



WPEX1



WPEX2



WPEX3

Catalog Number	Description	Color	3rd Party Compliance
			UL
Gaskets			
GASKET2	1/8" Thick, Weatherproof, 1 Gang, Multiuse Gasket, Closed Cell Polyethylene	Black	•
GASKET38 GASKET38-W	3/8" Thick, Weatherproof, 1 Gang, Multiuse Gasket, Closed Cell Polyethylene	Black White	•
NEW GASKET3726	3/32" Thick, Weatherproof, 1 Gang, Decorator Multiuse Gasket, Closed Cell Polyethylene	Gray	•
NEW GASKET3780	3/32" Thick, Weatherproof, 1 Gang, Duplex Multiuse Gasket, Closed Cell Polyethylene	Gray	•
WPGAS100	1/8" Thick, Weatherproof, 1 Gang, Multiuse Gasket	Black	
WPGAS101	1/8" Thick, Weatherproof, 2 Gang, Multiuse Gasket	Black	
WPGASR101	1/8" Thick, Weatherproof, Round, Multiuse Gasket	Black	

Catalog Number	Description	Color	3rd Party Compliance	
			cULus	SIF
Accessories				
	WPEX1 1 Gang Extension Ring, 9.5 Cu. In. 2.75" x 4.5" x 1"	Gray	•	
	WPEX2 2 Gang Extension Ring, 16.3 Cu. In. 4.5" x 4.5" x 1"	Gray	•	
	WPEX3 WPEX3-BR WPEX3-W Round Device Box Extension 4-1/2" Hubs	Gray Bronze White	•	
	WPEX4 1 Gang Extension Ring with 4-1/2" Hubs, 2-1/2" Plugs Supplied 9.5 Cu. In.	Gray	•	
	WPEX5 1 Gang Flanged Extension Ring with 4-1/2" Hubs, 2-1/2" Plugs Supplied, 9.5 Cu. In.	Gray	•	
	WPEX6 1 Gang Extension Ring with 4-3/4" Hubs, 2-3/4" Plugs Supplied, 9.5 Cu. In.	Gray	•	
	WPEX7 1 Gang Flanged Extension Ring with 4-3/4" Hubs, 2-3/4" Plugs Supplied, 9.5 Cu. In.	Gray	•	
	WPBP50 WPBP50-BR WPBP50-W Closure Plug – 1/2"	Gray Bronze White	• • •	• • •
	WPBP75 WPBP75-BR WPBP75-W Closure Plug – 3/4"	Gray Bronze White	• • •	• • •
	WPBP100 Closure Plug – 1"	Gray	•	•
	WPBL100 Aluminum Lugs (2) and Self-Tapping Screws	Gray		

Weatherproof Boxes & Covers NEC Compliance

Choose the cover according to the location in which it is to be used.

Outdoor Wet Locations

NEC 406.8(B)(1)

Wet locations are defined as those subjected to saturation with water or other liquids, such as vehicle washing areas, unprotected locations exposed to weather, or in installations under ground or in concrete slabs or masonry in direct contact with the earth.

NEC Article 406.8(B)(1) requires that all 15 and 20 amp, 125 & 250 volt receptacles installed in wet locations must have an enclosure that is weatherproof, whether or not a plug is inserted. These receptacles must use a while-in-use cover, such as those shown below:

WIUC10-GL	WIUC10-SG	WIUC10-DGL	WIUC20-GL	WIUC10-CABRV	WIUC10-CABRH
WIUC10-CL	WIUC10-SC	WIUC10-DCL	WIUC20-CL	WIUC10-CAGV	WIUC10-CAGH
WIUC10-WL	WIUC10-SW	WIUC10-DWL	WIUC20-WL	WIUC10-CAWV	WIUC10-CAWH

Other Wet Locations

NEC 406.8(B)(2)

NEC Article 406.8(B)(2) applies to all other receptacles installed in wet locations not covered by Article 406.8(B)(1), such as indoor wet locations, or receptacles above 20 amps. In these cases, if the product intended to be plugged into a receptacle is not attended while-in-use (e.g., landscape lighting, holiday lights, etc), a while-in-use cover must be used, such as those mentioned above. If the product intended to be plugged into it will be attended while in use (e.g., portable tools, etc), then the receptacle may have an enclosure that is weatherproof when the attachment plug is removed, such as those shown below:

CA1-BRL	CA72-G	WPDTDKIT-W	3703	3780-SCLVBG
CA1-G	CA721-G	WPDTDKIT-WVC	3703-FS	3780-SCLVCW
CA1-GL	CA723-G	WPFLDKIT	3703-T	3780-SCLVWH
CA1-GS	CA725-G	WPFLDKIT-BR	3703-TCW	3780-SCMH
CA1-WL	CA726-G	WPFLDKIT-W	3710	3780-SCMHBG
CA126-GRY	CA78-G	WPGFIKIT	3710-FS	3780-SCMHCW
CA17-G	CA8-BRH	WPGFIKIT-BR	3720	3780-SCMHWH
CA18-G	CA8-BRV	WPGFIKIT-BRVC	3720-FS	3780-SCWH
CA2-BR	CA8-GH	WPGFIKIT-VC	3722-FS	3795
CA2-G	CA8-GJ	WPGFIKIT-W	3723	3796
CA2-GS	CA8-GV	WPGFIKIT-WVC	3723-FS	3797
CA2-W	CA8-GVFS	WPG-1	3724-FS	4504
CA26-BRH	CA8-WH	WPG-2	3726-SC	4510
CA26-BRV	CA8-WV	WPOUTKIT	3726-SCBG	4511
CA26-GH	CA8-WVFS	WPOUTKIT-BR	3726-SCCW	4512
CA26-GV	CA82-BR	WPOUTKIT-BRVC	3726-SCWH	4515
CA26-WH	CA82-G	WPOUTKIT-VC	3770-SC	4515-FS
CA26-WV	CA82-W	WPOUTKIT-W	3778	4516
CA262-G	WP13	WPOUTKIT-WVC	3780-SC	4517
CA268-BR	WP13-FS	WPWIUKIT-C	3780-SCBG	4600
CA268-G	WP23	WPWIUKIT-SC	3780-SCCW	7420
CA268-W	WPBJ22	WPWIUKIT-SW	3780-SCCWT	7700
CA7-BRV	WPDTDKIT	WPWIUKIT-W	3780-SCFBX	
CA7-GH	WPDTDKIT-BR	3393	3780-SCFBXCW	
CA7-GV	WPDTDKIT-BRVC	3700	3780-SCFBXWH	
CA7-WV	WPDTDKIT-VC	3700-FS	3780-SCLV	

Damp Locations

NEC 406.8(A)

Damp locations are defined as those protected from weather and not subject to saturation with water or other liquids, but subject to moderate degrees of moisture. Examples of such locations include partially protected locations under canopies, marquees, and roofed open porches not subjected to a beating rain or water runoff, as well as interior locations such as some basements, barns, and cold-storage warehouses.

NEC Article 406.8(A) requires that receptacles installed in damp locations must have an enclosure that is weatherproof when the receptacle is covered (attachment plug is not inserted and receptacle cover is closed).

An installation suitable for wet locations shall also be considered suitable for damp locations. Therefore, all catalog numbers shown above are also suitable for use in damp locations. The covers below are suitable for damp locations only, because the lid can be propped in the full open position.

3760

3763

3780

Weatherproof Boxes & Covers Notes

Pass & Seymour



Lined writing area consisting of 40 horizontal lines for notes.